



Motus Wave Sensor 5729

Preliminary Edition	28 April 2017	
1st Edition	13 November 2017	New added parameters and new structure

TABLE OF CONTENT

INTRODUCTION.....	6
CHAPTER 1 Short description and specifications of the Motus Wave Sensor	8
1.1 Description.....	8
1.2 Sensor Dimension	8
1.3 Sensor pin configuration and data output.....	9
1.3.1 Sensor pin configuration RS-232 and AiCaP communication	9
1.3.2 Sensor pin configuration external compass input	10
1.3.3 Sensor Grounding.....	11
1.4 User accessible sensor properties	12
1.5 Motus Wave Sensor 5729 Specifications	19
1.6 Manufacturing and Quality Control.....	19
CHAPTER 2 Theory of Operation.....	20
2.1 Wave Measurement.....	20
2.2 Sensor Integrated Firmware.....	20
2.3 Sensor offset compensation.....	21
2.4 Offset settings and use of External compass	22
2.5 Parameter list.....	23
2.6 Parameter calculation	24
2.7 Other wave descriptions	27
CHAPTER 3 Configuration via SmartGuard or SeaGuardII Datalogger	28
3.1 Introduction.....	28
3.2 Installation of the Sensor to SmartGuard or SeaGuardII	28
3.2.1 Starting up with Real-Time collector.....	28
3.2.2 Changing Values.....	31
3.3 Deployment settings	33
3.4 System Configuration.....	34
3.5 User Maintenance.....	37
3.5.1 Mandatory.....	39
3.5.2 Site Info	39
3.5.3 Serial Port.....	39
3.5.4 Buoy Settings.....	40
3.5.5 External Compass Settings.....	41
3.5.6 AiCaP Input Parameter Heading	42
3.5.7 Advanced System Output	43
CHAPTER 4 Stand-alone sensor configuration using AADI Real-Time Collector.....	44
4.1 Establishing a new connection.....	44

4.2 Configuration in the Control Panel	45
4.3 Device Configuration.....	46
4.4 Deployment Settings.....	47
4.5 System Configuration.....	48
4.5.1 Common settings	49
4.5.2 Terminal Protocol settings.....	49
4.5.3 Processing Dependencies	50
4.5.4 Output Settings	51
4.6 User Maintenance settings.....	53
4.6.1 Mandatory.....	54
4.6.2 Site Info	54
4.6.3 Serial Port.....	54
4.6.4 Buoy Settings.....	55
4.6.5 External Compass Settings.....	56
4.6.6 Advanced System Output	57
4.7 Logging data on PC	58
4.7.1 Enabling file output	58
4.7.2 Starting the sensor and logging to file	59
4.8 Viewing incoming data in real-time.....	60
CHAPTER 5 Sensor configuration using Smart Sensor Terminal protocol.....	62
5.1 Communication setup	62
5.2 Sensor startup	63
5.3 Description of protocol	64
5.3.1 Passkey for write protection	65
5.3.2 Save and Reset	65
5.3.3 Available commands.....	66
5.3.4 The Get command	67
5.3.5 The Set command.....	68
5.3.6 XML commands.....	68
CHAPTER 6 Use of External Compass	70
6.1 General information	70
6.2 External compass types.....	71
6.2.1 Buoy Orientation 4164A	71
6.2.2 HSC 100-NMEA.....	72
CHAPTER 7 Electro Magnetic Compatibility and Cables	73
7.1 EMC Testing.....	73
7.2 Cables	73
7.3 Power – Voltage range	73
CHAPTER 8 Maintenance	Error! Bookmark not defined.

8.1 General.....	74
8.2 Retrieval of the sensor	74
8.3 Factory service	75
8.4 Example of Test & Specifications sheet and Certificates.....	76
CHAPTER 9 Installation	77
9.1	77
9.2 Mounting Brackets	77
9.3 Connecting Cables	78
9.4 Mounting considerations EMM 2.0	79
9.4.1 Magnetic distortion areas on EMM 2.0	79
9.4.2 Recommended sensor location	79
9.4.3 Connecting cables	80
9.4.4 Sensor mounting arrangement.....	80
9.5 Mounting considerations Tideland SB-138P	81
9.5.1 Magnetic distortion areas on Tideland SB-138P.....	81
9.5.2 Recommended sensor location	82
9.5.3 Connecting cables	82
9.6 Sensor mounting arrangement.....	82
9.7 MOORING	83
9.7.1 General mooring information.....	83
9.7.2 Mooring example EMM 2.0	84
9.8 Mooring Example Tideland SB-138.....	85
9.8.1 Mooring component example for Tideland SB-138P	86
9.9 Application examples	87

INTRODUCTION

Purpose and scope

This document is intended to give the reader knowledge of how to operate and maintain the Aanderaa Motus Wave Sensor 5729. The sensor is made for integration with either EMM 2.0 buoy or Tideland SB - 138 buoys. The sensor is a part of the Aanderaa buoy package Aanderaa EMM 2.0 Motus buoy or the Aanderaa SB – 138 Motus Buoy. Both buoy package are standard solutions with a wide range of optional parameters available both for meteorological and hydrological measurements. The sensor is also available as Sensor Kit for mounting on existing EMM 2.0 or Tideland SB-138 buoys. The sensor and integrations on both buoys are described in a single manual since the measurement principle and operation of sensor are the same.

The sensor utilize common communication protocols at the RS-232 interface where the Smart Sensor Terminal protocol is a simple ASCII command string based protocol and the AADI Real Time is an XML based protocol. When used together with one of the Aanderaa Dataloggers the CAN bus based AiCaP communication protocol may also be used.

Document Overview

CHAPTER 1 is a short description of the sensor and its configuration properties.

CHAPTER 2 gives the theory of operation and list of all parameters.

CHAPTER 3 is an overview of how to configure and log data with AADI Real-Time Collector when the sensor is connected via SeaGuardII or SmartGuard.

CHAPTER 4 is an overview of how to configure and log data with AADI Real-Time Collector when the sensor is used stand-alone.

CHAPTER 5 describes sensor configuration using Smart Sensor Terminal protocol when used with terminal software.

CHAPTER 6 describes the use of External Compass

CHAPTER 7 describes the sensor electromagnetic compatibility (EMC) and cables

CHAPTER 8 gives information about maintenance.

CHAPTER 9 describes installations of sensor on a buoy and information about all available accessories.

Applicable Documents

Form 855	Test & Specification Sheet
Form 856	Calibration Certificate, Temperature Sensor
Form 667	Pressure Certificate
D-417	Data sheet Motus Wave Sensor 5729
TD 303	Operating Manual for SeaGuardII Platform
TD 268	AAI Real-Time collector operating manual
TD 293	Operating Manual SmartGuard

Abbreviations

ADC	Analog to Digital Converter
AiCaP	Aanderaa Protocol: Automated idle Line CANbus Protocol
ASCII	American Standard Code for Information Interchange
CAN	Controller Area Network - sometimes referred to as CANbus
DAC	Digital to Analog Converter
DSP	Digital Signal Processor
EMC	Electromagnetic compatibility
EIA	Electronic Industry Alliance
EPROM	Erasable Programmable Read Only Memory
MSB	Most Significant Bit
NOAA	National Oceanic and Atmospheric Administration
RTC	Real Time Clock
UART	Universal Asynchronous Receiver and Transmitter
UNESCO	The United Nations Educational, Scientific and Cultural Organization
USB	Universal Serial Bus

CHAPTER 1 Short description and specifications of the Motus Wave Sensor

1.1 Description

Motus Wave sensor is a directional sensor module for use on surface buoys. The sensor is tested and approved for use with YSI EMM 2.0 and Tideland SB-138P buoys. The sensor can either be connected to an Aanderaa Datalogger using the AiCaP protocol or to any third party logger using RS-232. The sensor is using a build-in solid state 9-axis accelerometer/gyro/magnetometer to measure the movement of the buoy. These measurements are then processed inside the sensor and a wide range of parameters as well as wave spectrum are presented directly from the sensor in real-time. The sensor is equipped with an internal compass in order to reference directional data to geographical or magnetic north. If the magnetic field is disturbed by the buoy structure or payload an optional external compass may be used. In order for the wave sensor to fully capture the required movements of the buoy a more flexible mooring is required. To obtain the required flexibility one section of the mooring should consist of a rubber cord. Guidelines for mooring design are available in CHAPTER 9.

1.2 Sensor Dimension

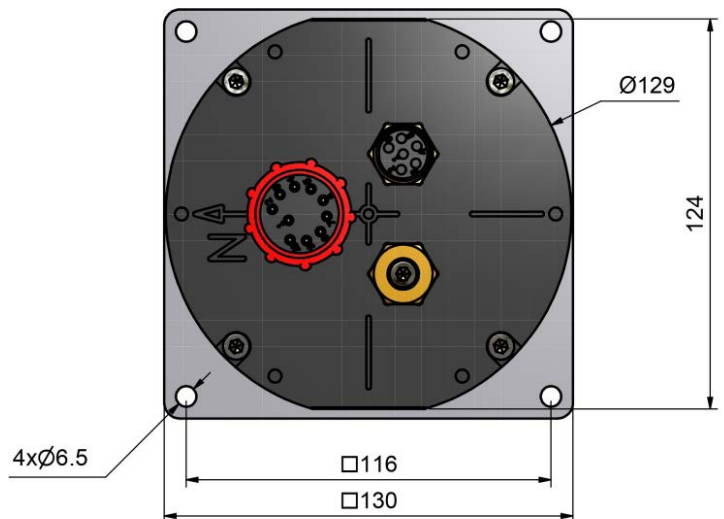
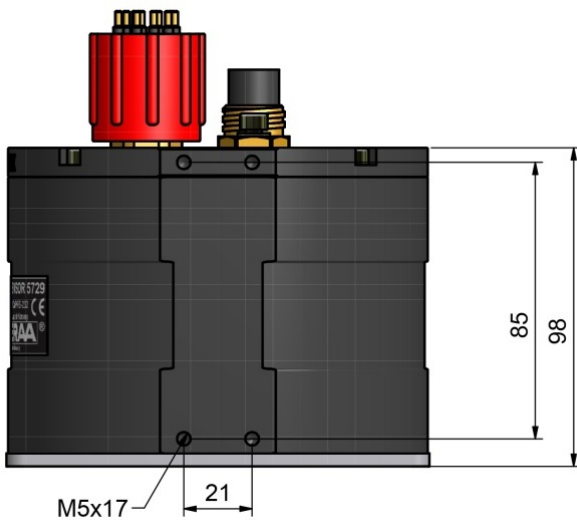

Figure 1-1: Sensor Dimension side view

Figure 1-2: Sensor Dimension top view

1.3 Sensor pin configuration and data output

Motus are using a 10-pin underwater mateable connector, WET-CON MCBH10M from SeaConn for RS-232 and AiCaP communication between sensor and logger; see Table 1-1 for pin configuration. It also uses a 6-pin underwater mateable connector, WET-CON MCBH6F from SeaConn for RS-232/RS-422 connection to external compass; see Table 1-2 for pin configuration. For a list of available cables see chapter 9.2 or contact aanderaa.sales@xyleminc.com.

1.3.1 Sensor pin configuration RS-232 and AiCaP communication

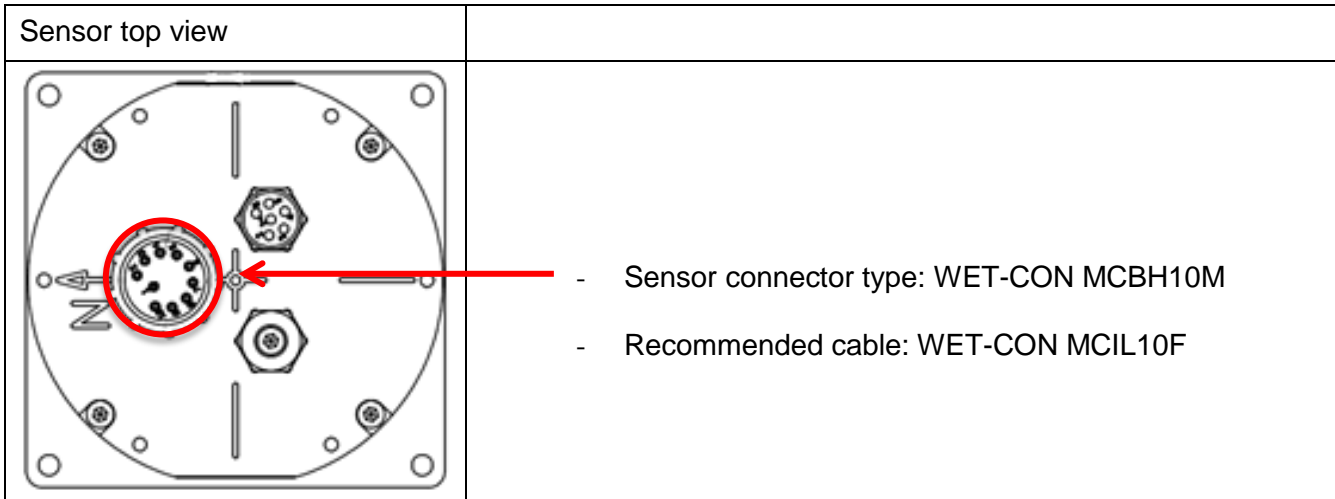

Figure 1-3 Sensor communication port 10-pin plug

Sensor Signal name	Input (I)	Sensor plug	Connecting Cable
	Output (O)	MCBH10M. Pin no:	MCIL10F. Pin no:
TXD	O	1	1 Black
RXD	I	2	2 White
VPWR	I	10	10 Orange/ Black
GND	-	9	9 Green/Black
NCE		7	7 White/Black
NCR		6	6 Blue
CAN_GND	-	5	5 Orange
CAN_H		3	3 Red
CAN_L		4	4 Green
BOOT ENABLE	I	8	8 Red/Black

Table 1-1: Sensor pin configuration 10-pin plug

1.3.2 Sensor pin configuration external compass input

<p>Sensor top view</p> 	<ul style="list-style-type: none"> - An external compass can be connected to the wave sensor via the sensors dedicated WET-CON MCBH6F connector. - Recommended cable: WET-CON MCIL6M - Output voltage: Sensor supply voltage, (VPWR) - Maximum Current Drain: 0.8A - Acceptable data format: NMEA 0183 “HDG” output
---	--

Figure 1-4 External compass input 6-pin plug

Signal name	Input (I) Output (O)	Sensor plug Pin no: MCBH6F	Connecting Cable Pin no: MCIL6M	Remarks
RX-	I	4	4 Green	
RXD/RX+	I	3	3 Red	
TXD/TX-	O	6	6 Blue	
TX+	O	5	5 Orange	
Compass GND	-	2	2 White	
Compass PWR	O	1	1 Black	Voltage =VPWR

Table 1-2: Sensor pin configuration for external compass 6-pin plug

1.3.3 Sensor Grounding

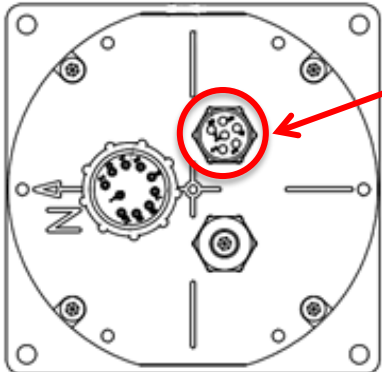
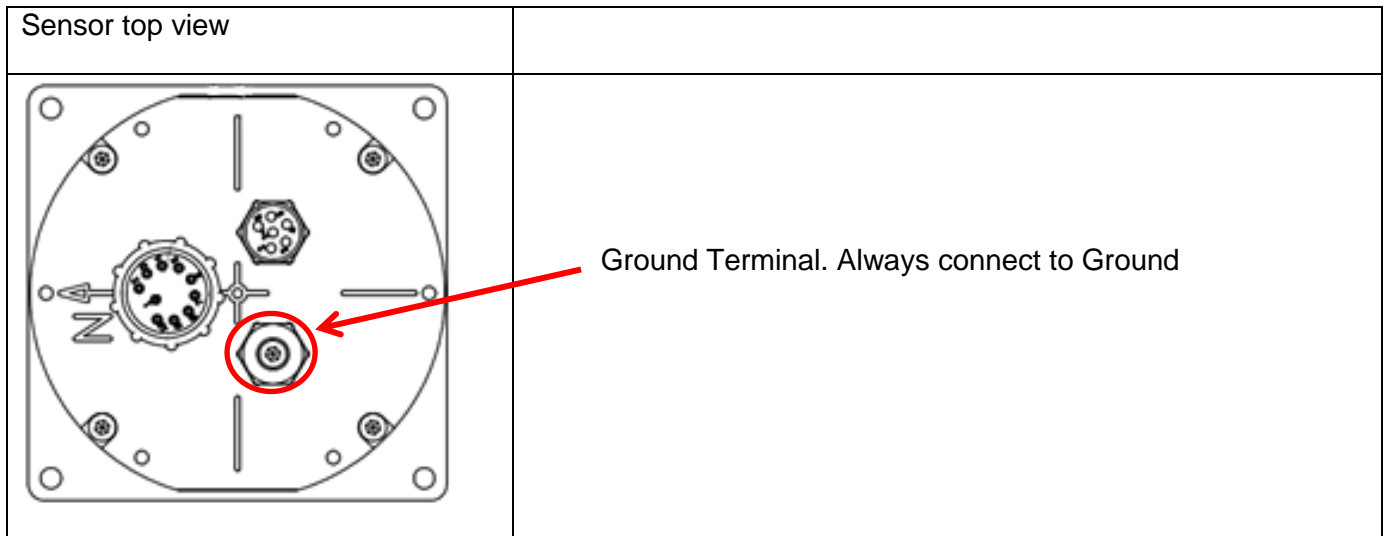

Figure 1-5 Sensor grounding

1.4 User accessible sensor properties

All configuration settings that determine the behavior of the sensor are called properties and are stored in a persistent memory block (flash). One property can contain several data elements of equal type (Boolean, character, integer etc.). The different properties also have different access levels and to get access to these a passkey must be set according to the protection level before changing the value, refer chapter 5.3.1

Some properties of the 'AiCaP' sensor will not be applicable or visible when the sensor is connected to a SeaGuardII or SmartGuard Datalogger, as these properties will be controlled by the instrument.

Table 1-3: Sensor properties for Motus Wave Sensor 5729

FC = Factory Configuration, UM = User Maintenance, SC = System Configuration, DS = Deployment Setting. ENUM=Enumeration, INT =Integer, BOOL=Boolean ('yes'/'no')

Table 1-1 Property	Type	No of elements	Use	Configuration Category	Access Protection RS232 applications
<i>Product Name</i>	String	31	AADI Product name	FC	Read Only
<i>Product Number</i>	String	6	AADI Product number		
<i>Serial Number</i>	INT	1	Serial Number		
<i>SW ID X</i>	String	11	Unique identifier for internal firmware, Software Identifier, X=1..2		
<i>SW Version</i>	INT	3	Software version (Major, Minor, Built)		
<i>SW Version 2</i>	INT	3	Software version (Coprocesor)		
<i>HW ID X</i>	String	19	Hardware Identifier, X =1..3		
<i>HW Version X</i>	String	9	Hardware Identifier, X =1..3		
<i>System Control</i>	INT	3	For AADI service personnel only		
<i>Production Date</i>	String	31	AADI production date, format YYYY-MM-DD		
<i>Last Service</i>	String	31	Last service date, format YYYY-MM-DD, empty by default		
<i>Last Calibration</i>	String	31	Last calibration date, format YYYY-MM-DD		
<i>Calibration Interval</i>	INT	1	Recommended calibration interval in days		
<i>Fe Image File Name</i>	String	31	Front Image File Name		
<i>Interval[s]</i>	Float	1	Data output interval in seconds	DS	No

<i>Location</i>	String	31	User setting for location	DS	No		
<i>Geographic Position</i>	String	31	User setting for geographic position, format XX.XXXXXX,X.XXXXX				
<i>Vertical Position</i>	String	31	User setting for describing sensor position				
<i>Reference</i>	String	31	User setting for describing sensor reference.				
<i>Mode</i>	ENUM	1	Sets the sensor operation mode (AiCaP, Smart Sensor Terminal, AADI Real-Time).	SC	Low		
<i>Enable Sleep</i>	BOOL	1	Enables sleep mode in Smart Sensor Terminal and AADI Real-Time operation (In AiCaP the sensor always tries to sleep when not busy). Default is 'Yes'				
<i>Enable Polled Mode</i>	BOOL	1	Enables polled mode in Smart Sensor Terminal Mode. When set to 'no' (non-polled operation) the sensor will sample at the interval given by the <i>Interval</i> property. When set to 'yes' the sensor will start measurement at the time of power up. A <i>Do Sample</i> command triggers the end calculations and output of data. A <i>Do Output</i> command can be sent to repeat the output of the last calculated data. Default is 'No'				
<i>Enable Text</i>	BOOL	1	Controls the insertion of descriptive text in Smart Sensor Terminal mode, i.e. parameter names and units. Can be used to reduce message size.				
<i>Enable Decimalformat</i>	BOOL	1	Controls the use of decimal format in the output string in Smart Sensor Terminal mode. Default is scientific format (exponential format).				
<i>Water Depth</i>	Float	1	Water Depth surface to sea bed. [m]			SC	No
<i>Gravity</i>	Float	1	Gravity [m/s ²]				
<i>High Frequency Limit (Hz)</i>	Float	1	Lower cut-off frequency in Hz. The default value is 0.7Hz= 1/0.7 = 1.42second, this is also equal to the lowest wave period we can measure.				
<i>Low Frequency Limit (Hz)</i>	Float	1	Higher cut-off frequency in Hz. The default value is 0.03333Hz = 1/0.3333 = 30seconds. The range is maximum 33seconds = 0.03030Hz.				
<i>Wave Integration Time</i>	ENUM	1	Integration time used for wave calculation. 5 min,10 min,15 min,20 min,25 min,30 min,35 min,40 min,45 min,50 min,55 min,1 hour. Default is 30min.				
<i>Timeseries record length</i>	Float	1	Length of each temeries.5 min,10 min,15 min,20 min,25 min,30 min,35 min,40 min,45 min,50 min,55 min,1 hour. Default is 30min.				
<i>Swell Wind Separation Frequency (Hz)</i>	Float	1	Separation Frequency used to separate swell from wind generated sea. Default is 0,1Hz				

<i>Significant Wave Height Unit</i>	ENUM	9	Metrics used for Significant Wave Height. Metric[m], Imperial [Feet]	SC	No
<i>Mean Spreading Angle Output</i>	ENUM	1	Configuration of Mean Spreading Angle Off, Storage, Output+Storage		
<i>First Order Spread Output</i>	ENUM	1	Configuration of First Order Spread Output Off, Storage, Output+Storage		
<i>Long Crestedness Output</i>	ENUM	1	Configuration of Long Crestedness Output Off, Storage, Output+Storage		
<i>Energy Spectrum Output</i>	ENUM	1	Configuration of Energy Spectrum Output Off, Storage, Output+Storage		
<i>Directional Spectrum Output</i>	ENUM	1	Configuration of Directional Spectrum Output Off, Storage, Output+Storage		
<i>Principal Dir Spectrum Output</i>	ENUM	1	Configuration of Principal Dir Spectrum Output Off, Storage, Output+Storage		
<i>Orbital Ratio Spectrum Output</i>	ENUM	1	Configuration of Orbital Ratio Spectrum Output Off, Storage, Output+Storage		
<i>Fourier Coeff Spectrum Output</i>	ENUM	1	Configuration of Fourier Coeff Spectrum Output Off, Storage, Output+Storage		
<i>Wave Peak Dir Wind Output</i>	ENUM	1	Configuration of Wave Peak Dir Wind Output Off, Storage, Output+Storage		
<i>Wave Peak Dir Swell Output</i>	ENUM	1	Configuration of Wave Peak Dir Swell Output Off, Storage, Output+Storage		
<i>Wave Mean Dir Output</i>	ENUM	1	Configuration of Wave Mean Dir Output Off, Storage, Output+Storage		
<i>Significant Wave Height Swell Hm0 Output</i>	ENUM	1	Configuration of Wave Height Swell Hm0 Output Off, Storage, Output+Storage		
<i>Significant Wave Height Wind Hm0 Output</i>	ENUM	1	Configuration of Wave Height Wind Hm0 Output Off, Storage, Output+Storage		
<i>Wave Height Hmax Output</i>	ENUM	1	Configuration of Wave Height Max Output Off, Storage, Output+Storage		
<i>Wave Height Max Trough Output</i>	ENUM	1	Configuration of Wave Height Max Trough Output Off, Storage, Output+Storage		
<i>Wave Height Max Crest Output</i>	ENUM	1	Configuration of Wave Height Max Crest Output Off, Storage, Output+Storage		
<i>Wave Period Tmax Output</i>	ENUM	1	Configuration of Wave Period Tmax Output Off, Storage, Output+Storage		

<i>Wave Mean Period Tz Output</i>	ENUM	1	Configuration of Wave Period Tz Output Off, Storage, Output+Storage	SC	No
<i>Significant Wave Height H13 Output</i>	ENUM	1	Configuration of Wave Height H13 Output Off, Storage, Output+Storage		
<i>Heave Time Series Output</i>	ENUM	1	Configuration of Wave Time Series Output Off, Storage, Output+Storage		
<i>Wave Mean Period Tm02 Output</i>	ENUM	1	Configuration of Wave Mean Period Tm02 Output Off, Storage, Output+Storage		
<i>Wave Peak Period Wind Output</i>	ENUM	1	Configuration of Wave Peak Period Wind Output Off, Storage, Output+Storage		
<i>Wave Peak Period Swell Output</i>	ENUM	1	Configuration of Wave Peak Period Swell Output Off, Storage, Output+Storage		
<i>Heading Output</i>	ENUM	1	Configuration of Heading Output Off, Storage, Output+Storage		
<i>External Heading Output</i>	ENUM	1	Configuration of External Heading Output Off, Storage, Output+Storage		
<i>Pitch and Roll Output</i>	ENUM	1	Configuration of Pitch and Roll Output Off, Storage, Output+Storage		
<i>System Parameters Output</i>	ENUM	1	Configuration of System Parameters Output Off, Storage, Output+Storage		
<i>Node Description</i>	String	31	User text for describing node, placement etc.	UM	High
<i>Owner</i>	String	31	User setting for owner		
<i>Interface</i>	String	31	Factory use only		
<i>Baudrate</i>	ENUM	1	RS232 baud rate: 4800, 9600, 57600, or 115200. Default set to 115200		
<i>Flow Control</i>	ENUM	1	RS232 flow control: 'None' or 'Xon/Xoff'. Default set to Xon/Xoff		
<i>Enable Comm Indicator</i>	ENUM	1	Enable communication sleep ('%') and communication ready ('!') indicators. After the last communication with the sensor, it normally outputs a '%' when the <i>Comm Timeout</i> time is over. When a character is sent to the sensor, it outputs a '!' to indicate that it is ready to communicate. Default is 'Yes'.		
<i>Comm TimeOut</i>	BOOL	1	RS232 communication activation timeout: Always On, 10 s, 20 s, 30 s, 1min, 2 min, 5 min, 10 min). Default is 30s.		

<i>Enable Off-centre Correction</i>	BOOL	1	Enables the correction of displacement errors due to a sensor located off the buoys rotational origin. The errors in the vertical displacement will have impact on the calculated significant wave height.	UM	High
<i>Off-centre XYZ (m)</i>	Float	3	The sensors installation position (X,Y,Z) relative to the rotation origin of the buoy. Based on this position and the sensors orientation sampled at 4Hz, the added displacement for the X,Y and Z component are coherently subtracted to the IMU based displacement. By activating this function the wave height and the wave direction are more precisely calculated for a wave sensor installed off the buoys rotational origin.		
<i>Enable Frequency Correction</i>	BOOL	1	Enables frequency correction of the buoy frequency response.		
<i>Correction Frequencies (Hz)</i>	Float	15	Selects the center frequency for each frequency correction		
<i>Correction Factors</i>	Float	15	Selects the correction values for the center frequencies given in the Frequency Scale.		
<i>Sensor Rotation Offset PRH (Deg)</i>	Float	3	Sensor rotation offset Pitch, Roll, and Heading. These values is added to the IMU calculated Pitch, Roll and Heading. These values do not change the calculated wave direction, but only the reported Wave Sensor Orientation. When post processing the wave directions using an external compass as reference these values must be subtracted from the Sensor Orientation before the External compass corrections are performed.		
<i>Enable Magnetic Declination</i>	BOOL	1	Enables use of magnetic declination angle input (see next property) ¹⁾		
<i>Declination Angle (Deg.M)</i>	Float	1	A value to correct for the magnetic variation on the site where the sensor is used. This is the angle in degrees between magnetic north and true north. ¹⁾		
<i>Enable Ext Compass Input</i>	BOOL	1	Enables external compass		
<i>Enable Ext Compass Correction</i>	BOOL	1	Enables external compass correction.		
<i>Ext Compass Alignment Offset (Deg.M)</i>	Float	1	External Compass Offset that is added to the sensor Heading.		
<i>Compass Type</i>	ENUM	1	Selectable compasses: Buoy Orientation 4164A, HSC100 NMEA or Generic NMEA ²⁾		

<i>Compass Warm-up Time (s)</i>	Float	1	The time needed from power is switched on to the external compass until it is ready to output compass data. Check the manual for the compass used and set the correct time.	UM	High
<i>Enable Compass Power Control</i>	BOOL	1	Enables power switching of the compass to save power ³⁾ . If disabled, the compass is always on.		
<i>Compass Start Offset Time (s)</i>	INT	1	Offset time from the start of a recording interval until the first start of the external compass. This offset time starts again from every recording interval start. Only used when Enable Compass Power Control is activated.		
<i>Compass Sampling interval (s)</i>	INT	1	This is the interval between each new start of the external compass sampling. This interval has to be bigger than N/f_s where N is the Compass Sample Average Number and f_s are the Compass Sampling frequency. Only used when Enable Compass Power Control is activated.		
<i>Compass Sample Average Number</i>	ENUM	1	Number of samples to be taken from the external compass and averaged before the power to the external compass is switched off again. Selectable number of values is 4, 8, 16, 32, 64 and 128. Only used when Enable Compass Power Control is activated.		
<i>Compass Sampling Frequency (Hz)</i>	Float	1	Only 1Hz supported, may be extended later		
<i>Heading Sensor Id</i>	ENUM	1	When the Wave Sensor is connected to AiCaP, a list of other available sensors connected to the SmartGuard/SeaGuard Datalogger is shown. This makes it possible to get a correct heading input from another sensor through the datalogger ⁴⁾ Only in AiCaP mode		
<i>Heading Parameter Id</i>	ENUM	1	A list of all available Heading parameters with Deg.M as unit is shown in the dropdown menu. Also other directions like for example Current direction from Doppler sensors is shown if connected to the same logger. Make sure that the correct heading parameter is selected. Only in AiCaP mode.		
<i>Heading Alignment Offset (Deg.M)</i>	Float	1	Offset added to the AiCaP external heading. Only in AiCaP mode.		
<i>Enable AiCaP Compass Correction</i>	BOOL	1	Enables the use of AiCaP external compass correction for wave direction calculation. Only in AiCaP mode.		

<i>Processing Time Output</i>	ENUM	1	Configuration of Processing Time Output Off, Storage, Output+Storage. This is an advanced system output which can be enabled to give more information when testing the operation of the sensor. This is the time used for processing all the data from the last wave integration time. Default is 'Off'.	UM	High
<i>FE State Parameters Output</i>	ENUM	1	Configuration of FE State Output Off, Storage, Output+Storage Two output parameters, FE State and FE Notifications are controlled by this setting. Default set to Off. This is an advanced system output which can be enabled to give more information about the internal coprocessor and communication between the host processor and the coprocessor. The output FE State parameter is 0 if everything is ok. The FE Notifications parameter gives information about the last communications with the coprocessor.		
<i>HW State Parameter output</i>	ENUM	1	Configuration of HW State Output Off, Storage, Output+Storage This is an advanced system setting which can be enabled to give more information about the internal electronic hardware. The output is 0 if everything is ok. Default set to Off.		

¹⁾ Magnetic declination (variation) is the angle between the magnetic north and the true north. This angle varies depending on the position on the Earth's surface and also varies over time. Declination is positive when magnetic north is east of true north and negative when it is to the west (input angle value $\pm 180^\circ$). Magnetic declination at the deployment location can be found for i.e. on NOAA website:

<http://www.ngdc.noaa.gov/geomag-web/>

²⁾ A generic NMEA compass can be selected. This generic NMEA compass has to be pre-configured; it cannot be configured through the Motus Wave Sensor. The baud rate of this NMEA compass has to be set to 4800.

³⁾ The "on" time of the external compass is controlled by the Warm-up Time, the Compass Sample Average Number and the Compass Sampling Frequency. The on/off duty cycle is also dependent on the Compass Sampling Interval which gives the time between each start (power on) of the external compass.

⁴⁾ The Motus Wave Sensor is also shown in this list. Make sure that an external sensor is selected and not the Wave Sensor itself.

1.5 Motus Wave Sensor 5729 Specifications

Refer Datasheet D 417 which is available on our web site <http://www.aanderaa.com> or contact aanderaa.info@xyleminc.com.

You will find the latest versions of our documents on Aanderaa website.

1.6 Manufacturing and Quality Control

Aanderaa Data Instruments products have a record for proven reliability. With over 50 years' experience producing instruments for use in demanding environments around the globe you can count on our reputation of delivering the most reliable products available.

We are an ISO 9001, ISO 14001 and OHSAS 18001 Certified Manufacturer. As a company we are guided by three underlying principles: quality, service, and commitment. We take these principles seriously, as they form the foundation upon which we provide lasting value to our customers.

CHAPTER 2 Theory of Operation

2.1 Wave Measurement

The wave measurement is based on an IMU with 9-axis accelerometer/gyro/magnetometer, The IMU operates at 1 kHz internally – 100Hz output for low pass filtering with 4Hz for wave calculation. Mechanical dampening acts as a low pass filter for the IMU-accelerometer in order to avoid aliasing and reduce low frequency noise. Due to coherent offset compensation the wave sensor can be installed off rotational origin for the buoy without introducing errors. The user enters the offset coordinates (x/y/z) for the installation. A user selectable buoy transfer function can be modified and activated. User selectable compass input. IMU compass, in-run IMU calibration or external compass are also available.

2.2 Sensor Integrated Firmware

The main tasks of the sensor's integrated firmware are to control the different sensor parts and calculate all parameters

All the user configurable properties that can be changed for each individual sensor, i.e. calibration coefficients, parameter outputs and configurations parameters, are called sensor properties, see chapter 1.4. When the sensor is connected to an Aanderaa logger the AiCaP mode is normally used. If connected to Aanderaa logger like SmartGuard or SeaGuardII using AiCaP the properties can be displayed and changed by using the AADI Real-Time Collector software, see CHAPTER 3. For a stand-alone sensor the properties may be displayed and changed either via the AADI Real-time Collector software, see CHAPTER 4 or using a terminal communication program, refer CHAPTER 5 via the RS-232 port. Examples of typical terminal emulation programs are Hyper Terminal and Tera Term.

In RS-232 mode the Motus sensor will perform a measurement sample and present the result within the first 1.5 seconds after the Motus has been powered up. However some of the parameter needs a number of samples before they can be calculated.

2.3 Sensor offset compensation

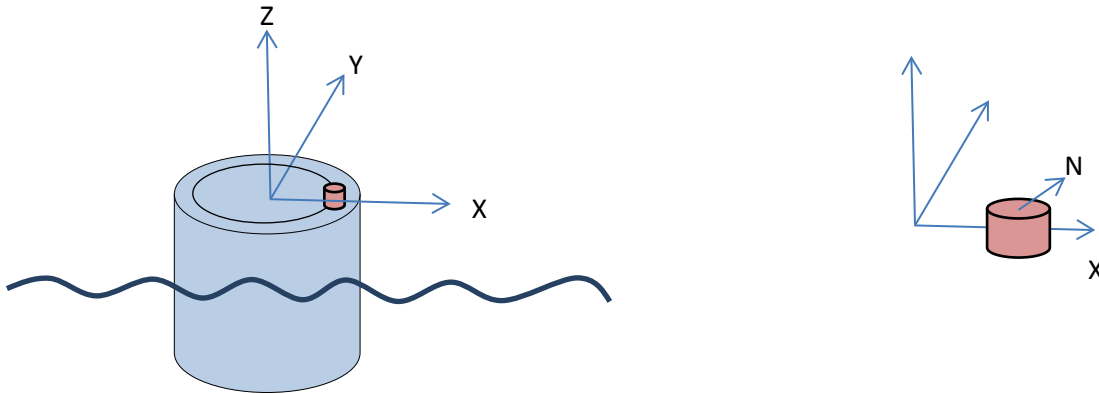
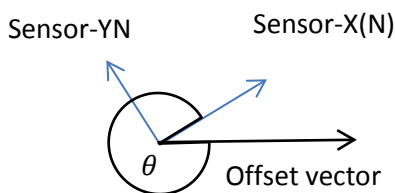

Figure 2-1: Buoy sensor offset geometry

The sensors axis system is defined by the orientation of the North mark of the sensor. This mark is aligned with the IMU x-axis. The sensor offset installation on the buoy has to be described relative to the sensor axis system. The easiest way to do this is to rotate the sensor such that the North mark on the buoy points directly away from the center of the buoy. By doing this the sensor offset will be aligned with the sensor x-axis. In this case the radius offset will be the x-axis offset, and the y-axis offset will be 0. The vertical offset is the height above the rotation origin. Normally the buoy water line would be sufficient accurate as reference for the vertical component (Z) of the rotation origin.

In case the installation prevents the sensor x-axis orientation to be aligned with the installation offset vector, the offset vector has to be decomposed into the sensor coordinate system according to Figure 2-1 and Figure 2-2.



$$X = \cos(\theta)$$

$$Y = -\sin(\theta)$$

Figure 2-2: Offset vector decomposition

The IMU pitch and roll is used together with the installation offset of the sensor in order to calculate the additional displacement of the sensor on a sample by sample basis and coherently subtract this value from the sensors reported values. Sea trials in Norwegian fjords indicate that the error introduced when not compensating for this effect can be in the order of 10 -15 % (40cm installation offset) depending on the sea state and spectral distribution of the waves.

2.4 Offset settings and use of External compass

Figure 2-3 shows how the different Offset settings and External compass is used inside the sensor to improve the measurement. White colored boxes are sensor input either from External compass or internal measurements. Red colored boxes are property setting set by the operator if enabled. Blue boxes are the internal processing and green boxes are Data Output from the sensor. See CHAPTER 6 for how to use external compass. Offset settings and external compass settings are listed in Table 1-3 and description are found in chapter 3.5.4 to 3.5.5 or chapter 4.6.4 to 4.6.5.

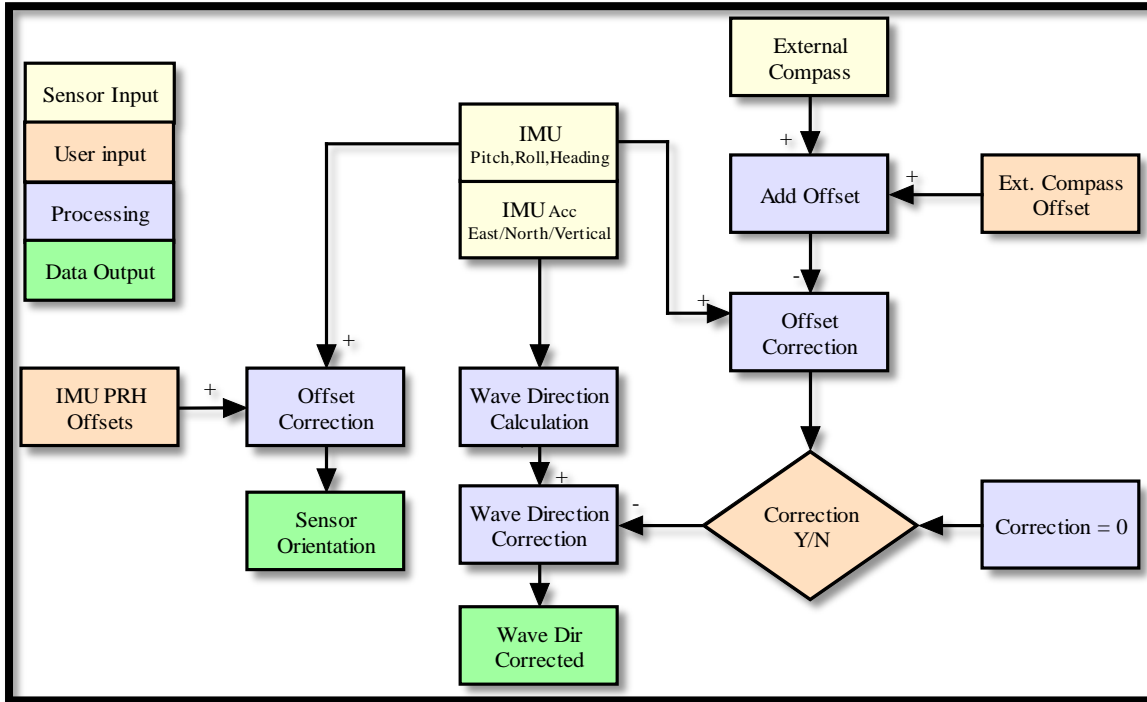

Figure 2-3: Offset settings and use of External compass

2.5 Parameter list

Table 2-1 Parameter list

<i>Output parameters</i>	<i>Symbol</i>	<i>Type</i>
Mean Spreading Angle	θ_k	Operational
First Order Spread	σ	Operational
Long Crestedness	τ	Operational
Energy Spectrum	E(f)	Research
Directional Spectrum	DWS _m (f)	Research
Principal Directional Spectrum	DWS _p (f)	Research
Orbital Ratio Spectrum	K(f)	Research
Fourier Coefficients Spectrum	A1(f),B1(f),A2(f),B2(f)	Research
Wave Peak Dir Swell/Wind	θ	Operational
Wave Mean Direction	θ_{avg}	Operational
Significant Wave Height H _{m0} Swell/Wind	H _{m0}	Operational
Wave Height H _{Max}	H _{Max}	Operational
Wave Height Max Trough	Tr _{max}	Operational
Wave Height Max Crest	C _{max}	Operational
Wave Period Tmax	T _{Max}	Operational
Mean Wave Period T _z	T _z	Operational
Significant Wave Height H _{1/3}	H _{1/3}	Operational
Heave Timeseries	H(t)	Operational/ Research
Wave Mean Period T _{m02}	T _{m02}	Operational
Wave Peak Period Swell/Wind	T _p	Operational

See description and calculation of all parameters in chapter 2.6.

MOTUS can be setup to define a range of parameters as Swell or as Wind driven. The threshold between Wind driven waves and Swell are given by **Swell Wind Separation Frequency (Hz)** where the default value is 0.1Hz=10second.

2.6 Parameter calculation

The **Energy Spectrum, $E(f)$** gives the vertical wave energy density for each frequency bin, accumulated from all directions.

Fourier Coefficients Spectrum, $A1(f)$, $B1(f)$, $A2(f)$, $B2(f)$ are used to calculate all frequency based parameters.

Two different directional Spectrums are calculated

1. **Direction Spectrum, $DWS_m(f)$** is calculated as mean wave direction for each frequency bin in the spectrum based on the first order Fourier Coefficients.

$$\theta_1(f) = \text{atan}(b_1(f_i)/a_1(f_i))$$

2. **Principal Dir Spectrum, $DWS_p(f)$** is calculated based on the second order Fourier Coefficients. The principal wave direction has an ambiguity direction of 180 degree, but is forced to be in the same interval as the mean wave direction.

$$\theta_2(f) = 0.5 \cdot \text{atan}(b_2(f_i)/a_2(f_i))$$

Orbital Ratio Spectrum, $K(f)$ gives the ratio of vertical to horizontal motions corrected for the wavenumber and water depth

$$K(f) = \left\{ \frac{1}{\tanh(k(f) \cdot h)} \right\} \cdot \sqrt{\frac{C_{11}(f)}{C_{22}(f) + C_{33}(f)}}$$

where:

$C_{11}(f)$, $C_{22}(f)$, and $C_{33}(f)$, are the cross-spectra of displacement in Vertical, East and North direction. $k(f)$, is the wave number and h is the water depth.

Wave Mean Direction, θ_{avg} is the energy weighted mean direction over all frequency bins.

$$\theta_{avg} = \text{atan} \left(\sum_i E(f_i) \cdot b_1(f_i)/a_1(f_i) \right)$$

The spreading angle is a measure of how wide the directional cone is over which the wave direction is distributed (Kumar and Anoop, 2013).

Three different spreading parameters are calculated.

1. **First Order Spread, σ** (Directional width) is a measure of directional spreading based on the first order Fourier coefficients, calculated for the frequency corresponding to the peak in the directional energy spectrum Kuik et al. (1988).

$$\sigma = \sqrt{2(1 - r_1)}, r_1 = \sqrt{a_1^2 + b_1^2}$$

2. **Mean Spreading Angle, θ_k** is the spreading function based on the first and second order Fourier coefficients, calculated for the frequency corresponding to the peak in the directional energy spectrum.

$$\theta_k = \text{atan} \left[\frac{0.5b_1^2(1 + a_2) - a_1b_1b_2 + 0.5a_1^2(1 - a_2)}{a_1^2 + b_1^2} \right]$$

3. **Long Crestedness Parameter, τ** gives the normalized spreading function, calculated for the frequency corresponding to the peak in the directional energy spectrum.

$$\tau = \frac{\sqrt{1 - \sqrt{a_1^2 + b_1^2}}}{\sqrt{1 + \sqrt{a_1^2 + b_1^2}}}$$

For long-crested waves the direction of all wave fronts are the same and the spreading function reaches 0. When the wave fronts no longer are uniform and then become more spread, the length of the wave crests will be shorter and the Long Crestedness parameter will increase.

Significant wave height is defined traditionally as the mean wave height (trough to crest) of the highest third of the waves ($H_{1/3}$). A modern definition of significant wave height is usually defined as four times the standard deviation of the surface elevation. The symbol H_{m0} is usually used for that latter definition. The significant wave height may thus refer to H_{m0} or $H_{1/3}$; the difference in magnitude between the two definitions is only a few percent.

Significant Wave Height, $H_{1/3}$ is the mean of the highest third of the waves in a time-series computed on the basis of a spectrum and is referred to as $H_{1/3}$.

Significant Wave Height Swell, H_{m0} is four times the standard deviation of the surface elevation. MOTUS can be setup to define a range of wave lengths as Swell. The significant wave heights of this range is called **Wave Height Swell H_{m0}**

Significant Wave Height Wind, H_{m0} is the range of waves defines as Wind. The significant wave heights of this range are called **Wave Height Wind H_{m0}** .

Heave Timeseries, $H(t)$ is the vertical displacement time series sampled at 4 Hz.

Wave Peak Period, T_p is the wave period with the highest energy. T_p can be calculated as;

$$T_p = \frac{1}{f_{max}},$$

where:

f_{max} is the frequency that gives the maximum energy in the specter $E(f)$.

Wave Peak Period Swell, T_p is calculated based on the frequency band defining the swell, typically 0.033-0.1 Hz. The crossover frequency between swell and wind can be modified.

Wave Peak Period Wind, T_p , is calculated based on the frequency band defining the wind generated waves, typically 0.1 – 0.7 Hz. The crossover frequency between swell and wind can be modified.

Wave Peak Direction, θ gives the direction of the peak wave period. The wave peak direction is calculated as;

$$\theta = atan2(b_1(f_{max}), a_1(f_{max})),$$

where:

f_{max} is the frequency that gives the maximum energy in the specter $E(f)$.

Mean wave period, T_z gives the mean wave period, T_m , is the mean of all wave periods in a time-series representing a certain sea state.

Wave Mean Period, T_{m02} is the mean wave period calculated from the spectrum.

$$T_{m02} = \sqrt{\frac{m_2}{m_0}},$$

where:

m_n is the n order moment calculated from the Energy spectrum as;

$$m_n = \int_0^{\infty} f^n E(f) df$$

Wave Height Max, H_{max} is the vertical distance between the highest (crest) and lowest (trough) parts of a wave.

Wave Period, T_{max} is the corresponding wavelength of the wave that is identified as wave height max.

Wave Height Max Crest, C_{max} is the highest positive wave amplitude above average water level within a record of waves.

Wave Height Max Trough, Tr_{max} is the highest negative wave amplitude below average water level within a record of waves

2.7 Other wave descriptions

Wave Crest is the point on a wave with the maximum value or upward displacement within a cycle

Wave Troughs is the point on a wave with the minimum or lowest point in a cycle

Wavelength is the distance from a certain point on one wave to the same point on the next wave (e.g. distance between two consecutive wave crests or between two consecutive wave troughs).

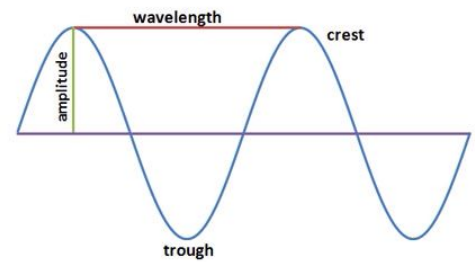

Figure 2-4: wave descriptions

Wave amplitude is one half the distances from the crest to the trough. Wave amplitude is a more technical term for wave height and is used in engineering technology.

Wave frequency is the number of waves passing a fixed point in a specified period of time. Frequency has units of waves per second or cycles per second. Another unit for frequency is the Hertz (abbreviated Hz) where 1 Hz is equivalent to 1 cycle per second.

Wave period are the time it takes for two successive crests (one wavelength) to pass a specified point.

Wave speed is the distance the wave travels divided by the time it takes to travel that distance. Wave speed is determined by dividing the wavelength by the wave period. In symbols $c = \lambda / T$, where c is the wave speed, λ (lambda) is the wavelength, and T is the period.

Wave Steepness is the ratio of height to wavelength. When wave steepness exceeds 1:7, breakers form. If a wave has height of one foot and a length from crest to crest of 8 feet, then the ratio is 1:8 and this wave is not going to break. But if the height is 1 foot and the length decreases to 5 feet, then the ratio is 1:5 and this wave has now become so steep that the crest topples and the wave breaks.

CHAPTER 3 Configuration via SmartGuard or SeaGuardII Datalogger

3.1 Introduction

The Motus Wave Sensor 5729 can easily be installed on a buoy using the Aanderaa SmartGuard or SeaGuardII platform to configure and collect data.

3.2 Installation of the Sensor to SmartGuard or SeaGuardII

See CHAPTER 9 for installation to SeaGuardII and SmartGuard. This chapter only describes the software and configuration of sensor. For more information about the SmartGuard and SeaGuardII, refer to the TD 293 and TD 303, Operating manual for SmartGuard and SeaGuardII.

3.2.1 Starting up with Real-Time collector

- Connect the supplied configuration cable between your PC's USB connector and the USB port on your logger. On SeaGuardII the port is located in front right hand side of the instrument and on SmartGuard the port is located on the left hand side just underneath the display.
- If the logger is connected via a RS-232 real-time connection or for SmartGuard via the LAN connection all configuration may also be done using this connection instead of the USB.
- Install and start the AADI Real-Time Collector software on your PC (provided on the CD delivered with the instrument). For more information about the AADI Real-Time Collector, refer TD 268 AADI Real-Time Collector Operating Manual
- Switch on the instrument by pressing or turning the power button.

NOTE!

When using a USB connection, you also need to install Windows Mobile Device Center (Windows Vista, and Microsoft Windows 7) if not already installed on your computer. It can be downloaded from Microsoft website.

Windows Mobile Device Center acts as device management and data synchronization between a Windows Mobile-based device and a computer.

Once the USB connection has been established, Windows Mobile Device Center will start automatically:

For other operating system please refer to user manual or contact aanderaa.support@xyleminc.com



Figure 3-1: Windows Mobile Device Center

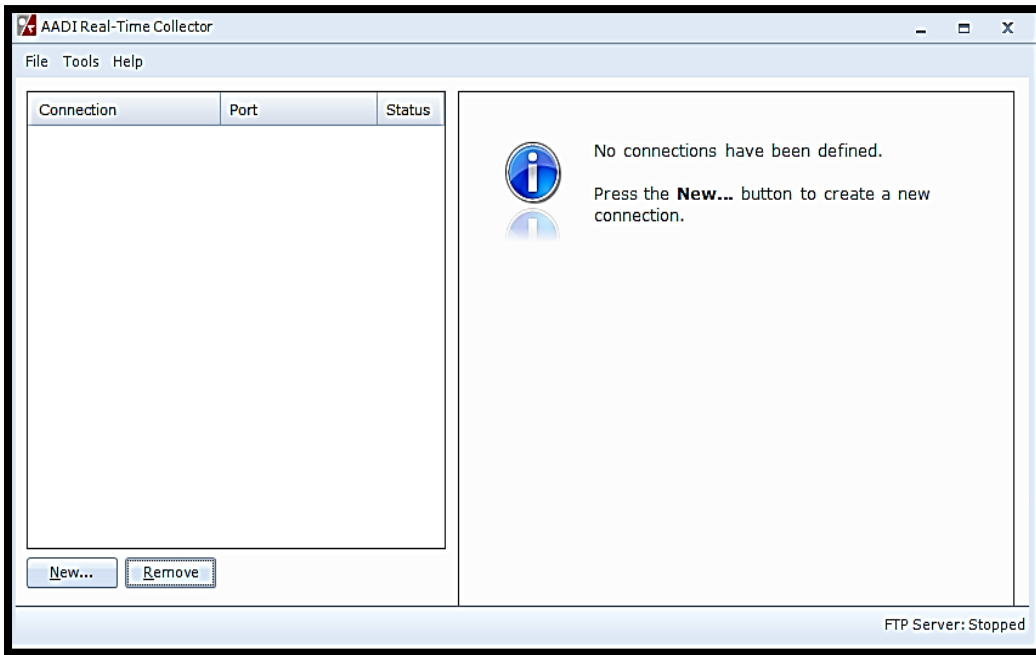

At first connection with AADI Real-Time Collector, it will generate the following interface.

Press the **New** button to create a new connection

Figure 3-2: AADI Real-Time Collector start up menu

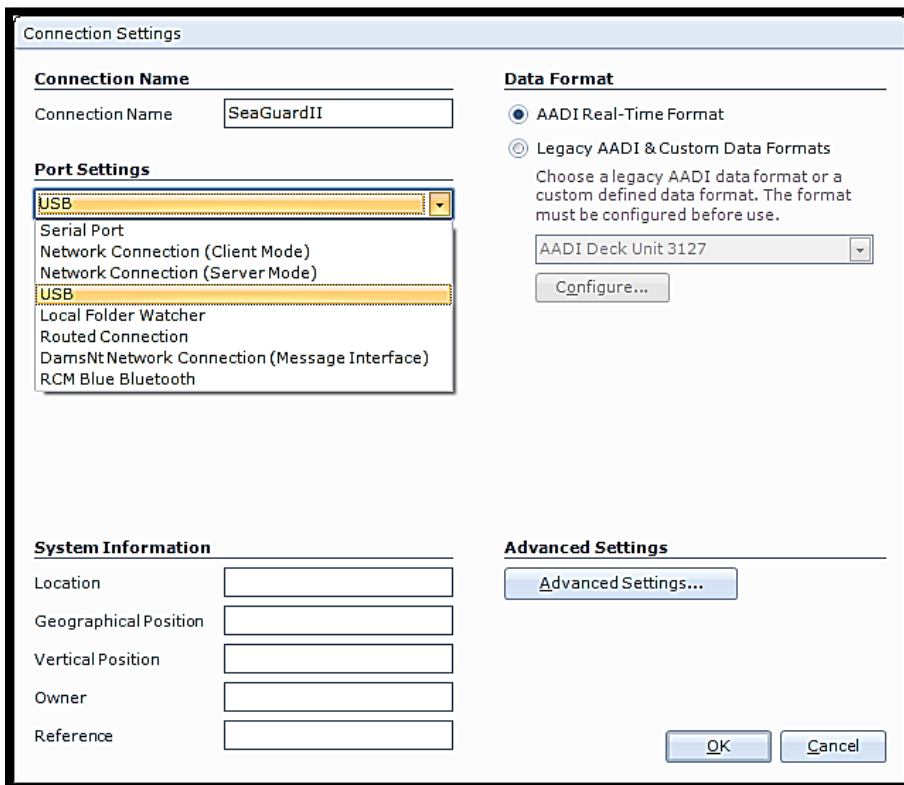

In the **Connection Name** box write a name specific for this connection (eg. SmartGuard or SeaGuardII and #serial number)

Select **USB** from the **Port Settings** drop down menu if using USB connection, **Serial Port** if using the serial real-time connection

Press **OK**.

Figure 3-3: AADI Real time Collector connection settings

NOTE: This procedure only needs to be done once. AADI Real-Time Collector will automatically reconnect to the instrument at next connection.

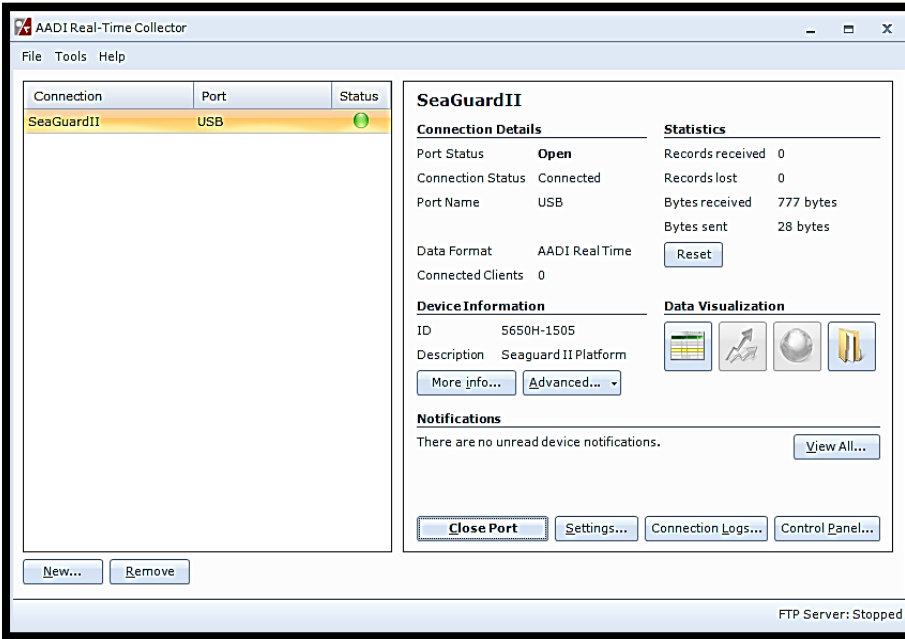

Figure 3-4: AADI Real-Time Collector main menu

Press **Open Port** and the connection to the SeaGuardII or SmartGuard should be established within a few seconds and the status turn to green.

Press **Control Panel** to continue.

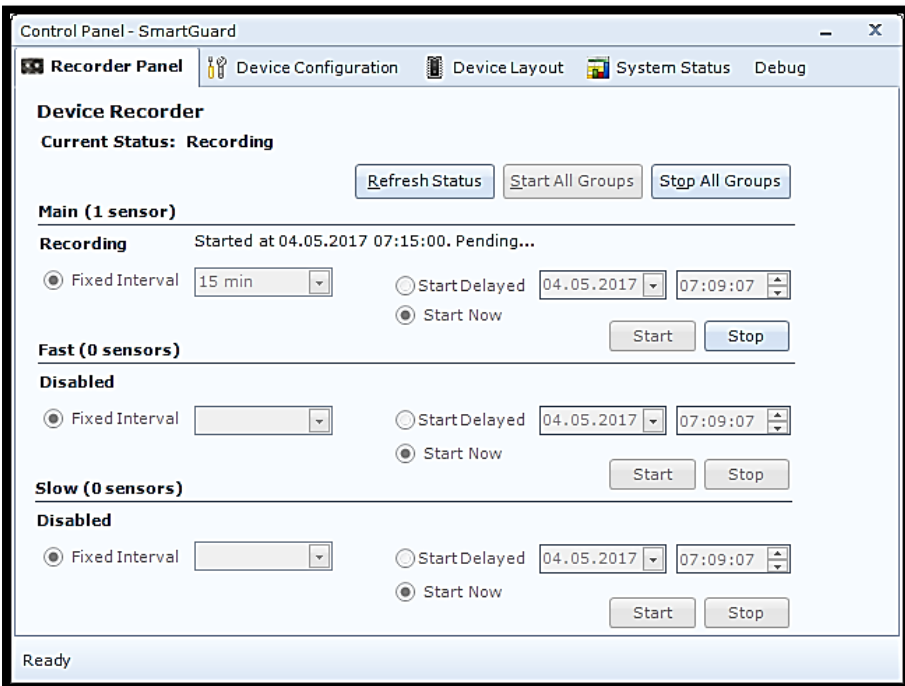

Figure 3-5: Recorder panel

Open **Recorder Panel**.

Note! The configuration cannot be changed during a recording session.

If the instrument is recording, under **Recorder Panel**, press **“Stop All Groups”**.

Each recording group may be set to either **Start Now** or **Start Delayed**

For more information on the settings related to the SeaGuardII or SmartGuard, refer to the TD 303, manual for the SeaGuardII Platform or TD 293, manual for the SmartGuard.

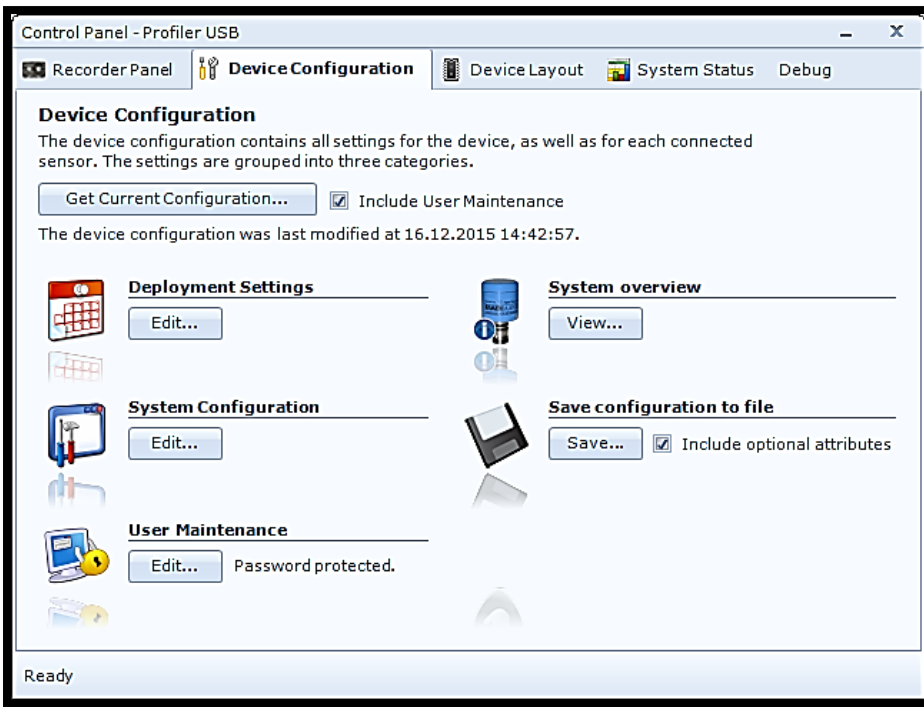

Settings related to Motus wave sensor can be configured under

Device Configuration

- **Deployment Settings**
- **System Configuration**
- **User Maintenance**

To access the settings in **User Maintenance** you need to select **Include User Maintenance** before clicking the **Get Current Configuration** and enter password: **1000**

Figure 3-6: Device configuration

3.2.2 Changing Values

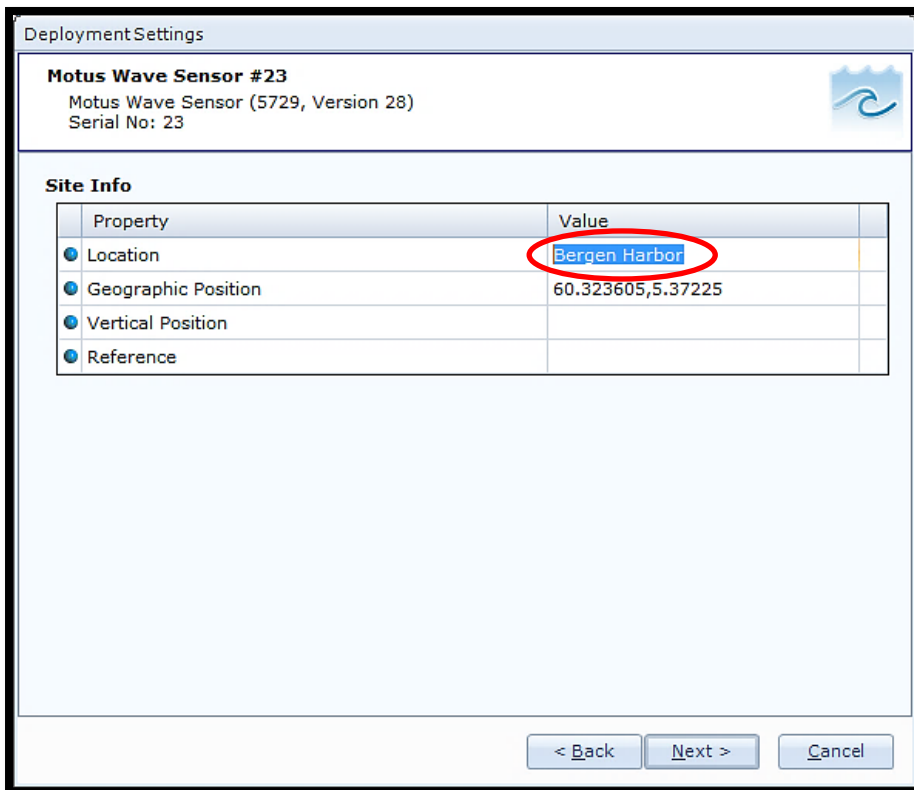

To change values enter the text or number in the value box and press **Next**.

Figure 3-7 Change value

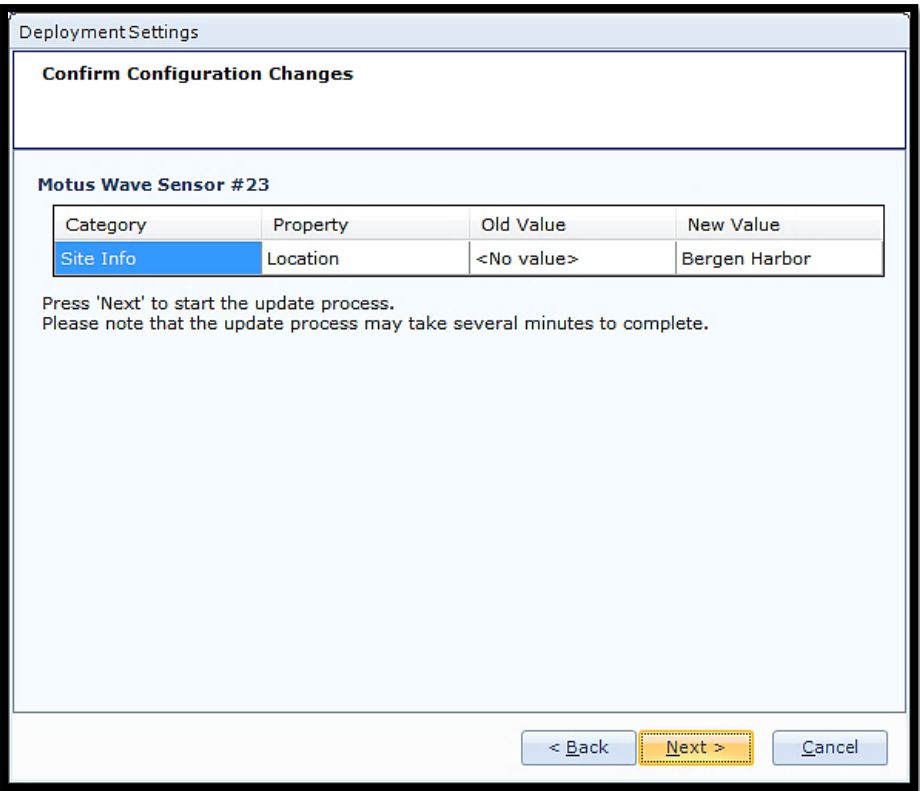

If the list of configuration changes is correct press **Next** to start the update process.

Figure 3-8 Confirm Configuration Changes

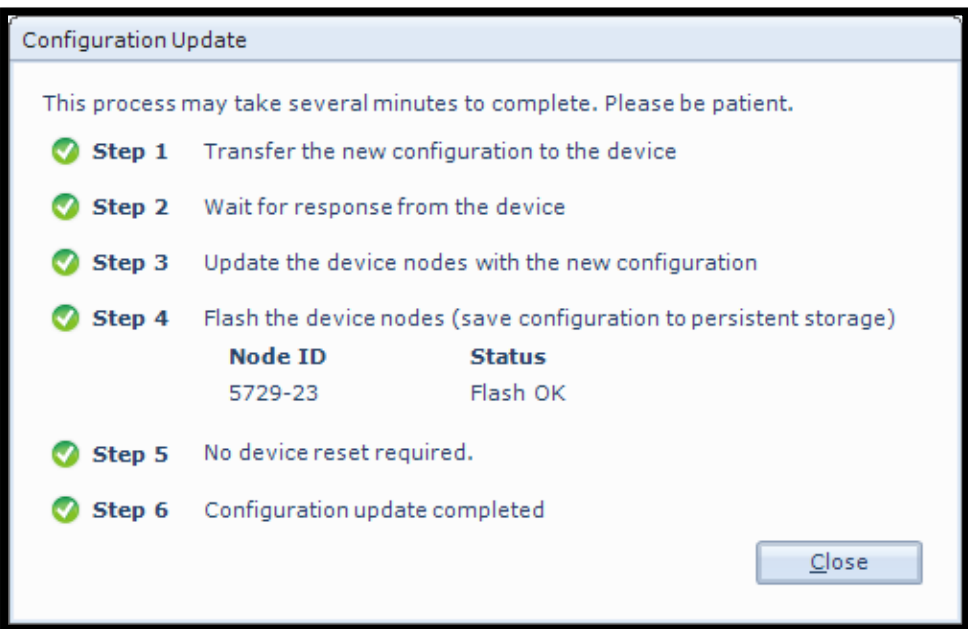

An automatic process will start with 6 steps transferring and storing the new information/setting in the sensor Flash. If necessary a reset will be executed. Do not switch off before the entire process is completed.

Figure 3-9 Configuration Update

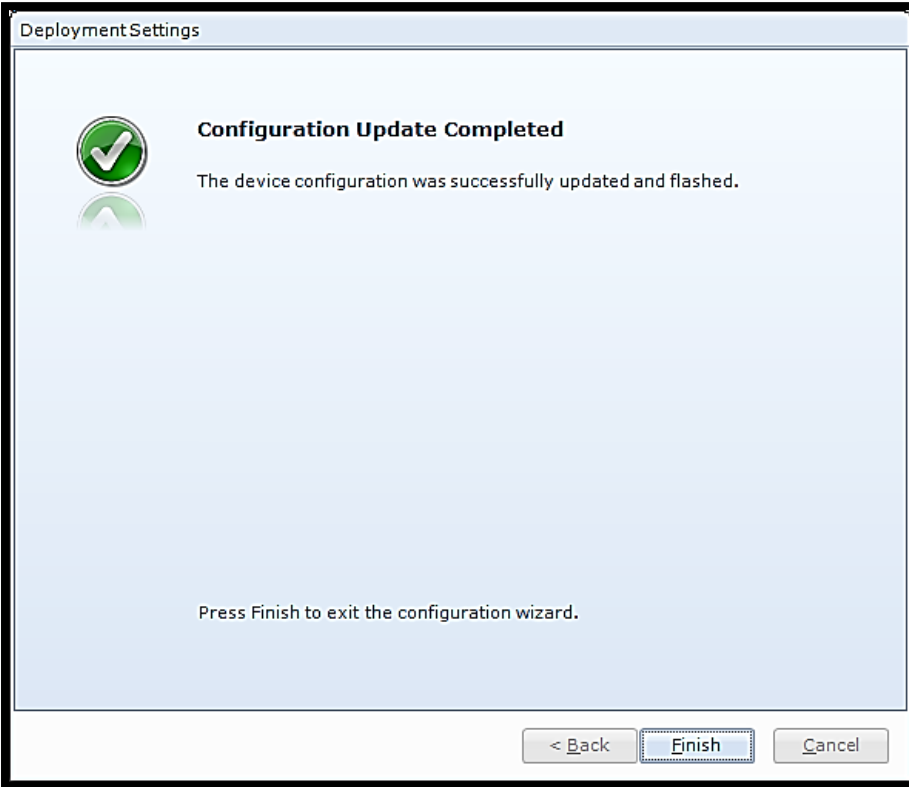

When the updating process is finished a confirmation will show up. Press Finish to continue.

Figure 3-10 Configuration Update Completed

3.3 Deployment settings

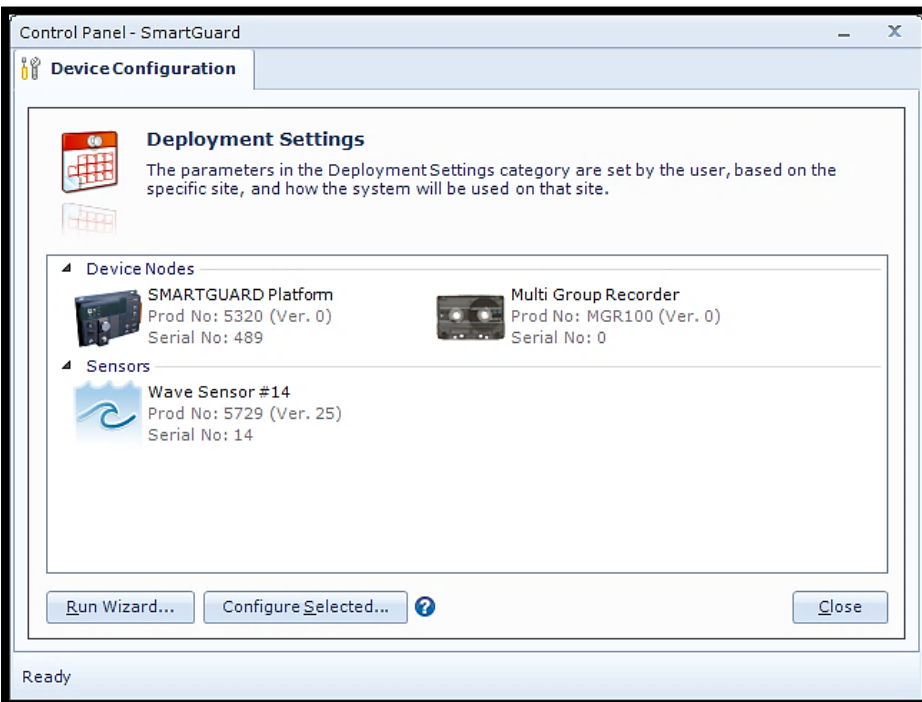

Select **Deployment settings** by double clicking the icon.

Under the **Sensors** section you will find a list of all sensors connected to the logger.

Double-click on the **Wave sensor** icon to select the sensor.

Multi Group Recorder is used to put the different sensors in one of the three recording groups. Each sensor can only be in one recording group.

Figure 3-11: Deployment settings main

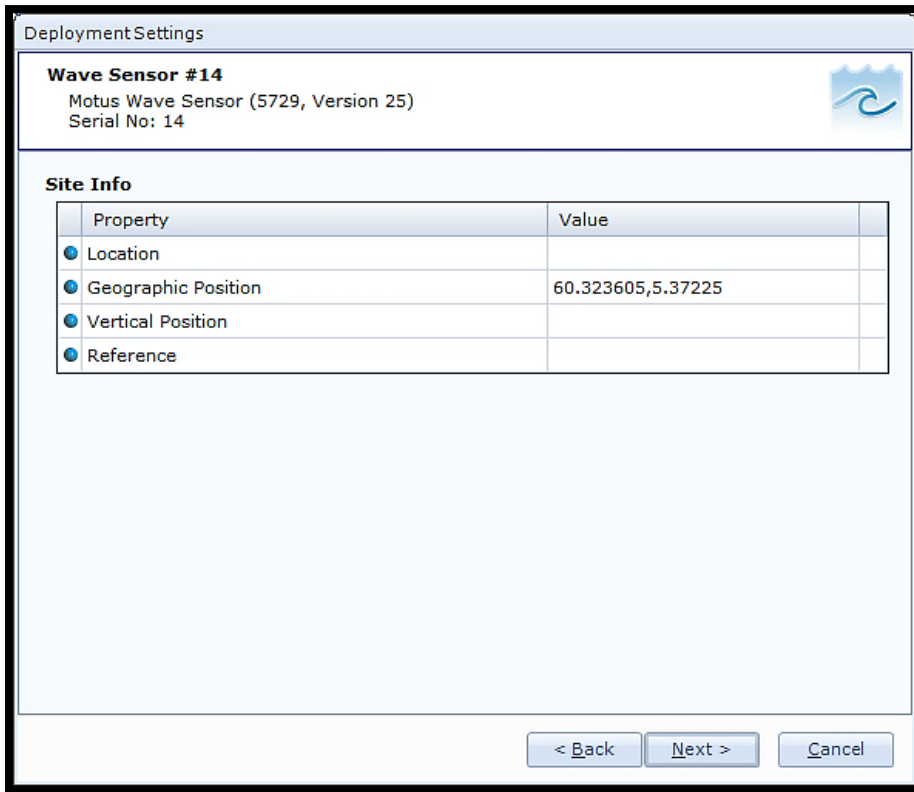

Deployment Settings consist of only one session; **Site Info** containing four properties:

- **Location**
- **Geographic Position**
- **Vertical Position**
- **Reference**

All these settings are optional information to be entered to store information about the deployment. These setting are not used in calculation. Geographical Position is used to give the map coordinates unless a GPS input is connected.

Figure 3-12: Wave sensor Deployment Settings

3.4 System Configuration

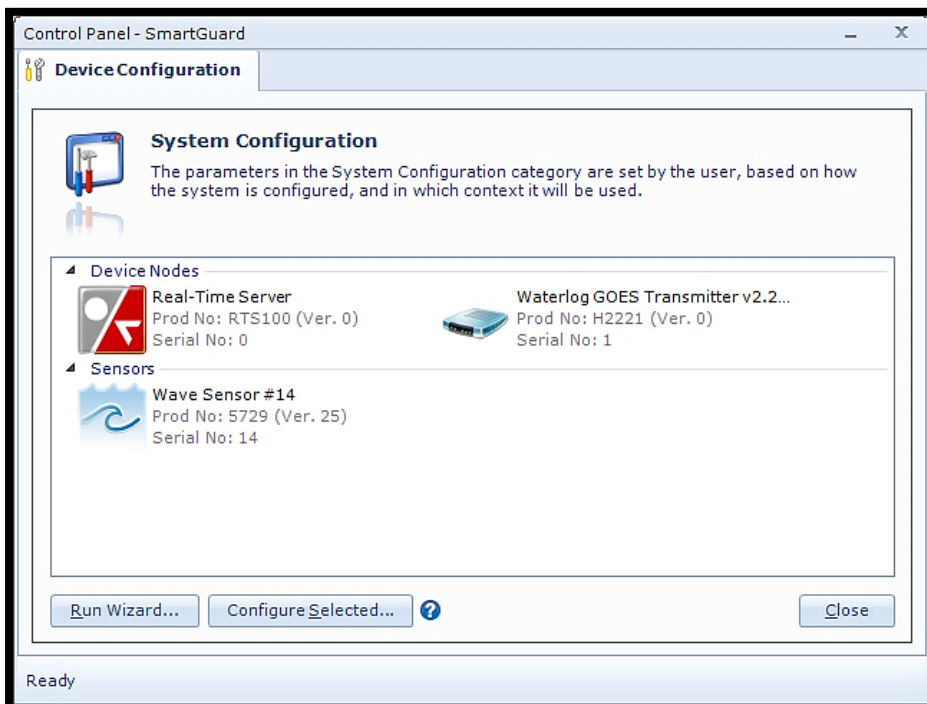

Select **System Configuration**

The different sensors connected to the same Datalogger will show up as selectable items.

Double-click on the **Wave Sensor**.

System Configuration are divided in two section

- **Processing Dependencies**
- **Output/Storage Settings**

Figure 3-13: System configuration main

System Configuration

Motus Wave Sensor #23
 Motus Wave Sensor (5729, Version 28)
 Serial No: 23

Processing Dependencies

Property	Value
Water Depth (m)	25.00
Gravity (m/s ²)	9.81
High Frequency Limit (Hz)	0.70
Low Frequency Limit (Hz)	0.03
Wave Integration Time	15 min
Timeseries record length	15 min
Swell Wind Separation Frequency (Hz)	0.10
Significant Wave Height Unit	Imperial [Feet]

Output/Storage Settings

Property	Value
Mean Spreading Angle Output	Off
First Order Spread Output	Storage
Long Crestedness Output	Output+Storage
Energy Spectrum Output	Storage
Directional Spectrum Output	Storage
Principal Dir Spectrum Output	Storage
Orbital Ratio Spectrum Output	Storage
Fourier Coeff Spectrum Output	Storage
Wave Peak Dir Wind Output	Storage
Wave Peak Dir Swell Output	Storage
Wave Mean Dir Output	Storage
Wave Height Swell Hm0 Output	Storage
Wave Height Wind Hm0 Output	Storage
Wave Height Hmax Output	Storage
Wave Height Max Trough Output	Storage
Wave Height Max Crest Output	Storage
Wave Period Tmax Output	Storage
Wave Mean Period Tz Output	Storage
Wave Height H13 Output	Storage
Heave Time Series Output	Storage
Wave Mean Period Tm02 Output	Storage
Wave Peak Period Wind Output	Storage
Wave Peak Period Swell Output	Storage
Heading Output	Storage
External Heading Output	Storage
Pitch and Roll Output	Storage
System Parameters Output	Storage

< Back Next > Cancel

Processing Dependencies are settings used in the wave calculation.

Water Depth (m) is the total water depth where the buoy is located in meter. The default setting is 25 meter.

Gravity (m/s²) is the local gravity constant in m/s². The default value is 9.81m/s²

High Frequency Limit (Hz) is the lower cut-off frequency in Hz. The default value is 0.7Hz= 1/0.7 = 1.42second, this is also equal to the lowest wave period we can measure.

Low Frequency Limit (Hz) is the higher cut-off frequency in Hz. The default value is 0.03333Hz = 1/0.3333 = 30seconds. The range is maximum 33seconds = 0.03030Hz.

Wave Integration Time is the period the sensor use to calculate all wave parameters. Range is 5 minutes to 60 minutes and default is 30 minutes.

Timeseries record length is the length of each timeseries. Range is 5minutes to 60 minutes and default is 30 minutes

Swell Wind Separation Frequency (Hz) is the frequency that separates wind from swell. Default value is 0.1Hz =10s. Waves with period bellow 10s are then considered as wind generated sea and waves above 10s are considered as swell.

Significant Wave Height Unit is the unit used to present Significant wave height, either metric(m) or imperial(feet). The default setting is metric(m).

Figure 3-14 Wave Sensor System Configuration

The second session is **Output/Storage Settings**. The alternatives in the drop down menu for each parameter are **Off**, **Storage and Output+Storage**, where **Off** means that the parameter is not calculated, **Output+Storage** means that the sensor instructs the Datalogger to send out a parameter in real-time in addition to saving the parameter to the SD card and **Storage are used** for only saving the data to the SD card.

Wave Parameters in this section are:

- **Mean Spreading Angle Output**
- **First Order Spread Output**
- **Long Crestedness Output**
- **Energy Spectrum Output**
- **Directional Spectrum Output**
- **Principal Dir Spectrum Output**
- **Orbital Ratio Spectrum Output**
- **Fourier Coeff Spectrum Output**
- **Wave Peak Dir Wind Output**
- **Wave Peak Dir Swell Output**
- **Wave Mean Dir Output**
- **Wave Height Swell H_{m0} Output**
- **Wave Height Wind H_{m0} Output**
- **Wave Height H_{max} Output**
- **Wave Height Max Trough Output**
- **Wave Height Max Crest Output**
- **Wave Period T_{max} Output**
- **Wave Mean Period T_z Output**
- **Wave Height $H_{1/3}$ Output**
- **Heave Time Series Output**
- **Wave Mean Period T_{m02} Output**
- **Wave Peak Period Wind Output**
- **Wave Peak Period Swell Output**

All these parameters are described in Table 1-3 and parameter calculation with description are given in chapter 2.6

Other non-wave parameters in this section are:

- **Heading Output** giving compass heading from the compass, Heading and StDev Heading
- **External Heading Output** giving the compass heading from an external compass if installed.
- **Pitch and Roll Output** giving pitch and roll from the internal tilt sensor. Pitch/Roll and StDev Pitch/Roll
- **System Parameters Output** giving sensor parameters: Input Voltage, Input Current and Memory Use

3.5 User Maintenance

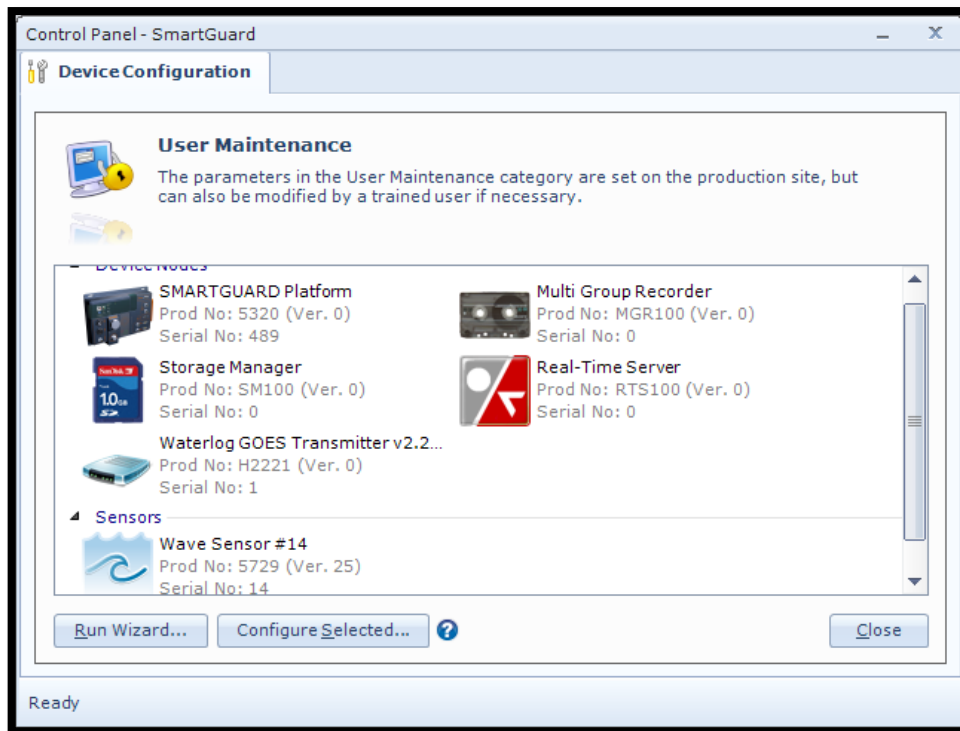

In **User Maintenance** you find properties that are password protected and are normally set/alterd by a trained user. It is not recommended to change properties unless instructed. To access these, check the **“Include User Maintenance”** box in the **Device configuration** before clicking on the **“Get Current Configuration...”** button. The password is: **1000**.

Select the **Wave Sensor** from the sensor list.

Figure 3-15: User Maintenance main

User Maintenance

Motus Wave Sensor #23
 Motus Wave Sensor (5729, Version 28)
 Serial No: 23

Mandatory

Property	Value
<input checked="" type="radio"/> Node Description	Motus Wave Sensor #23

Site Info

Property	Value
<input checked="" type="radio"/> Owner	

Serial Port

Property	Value
<input checked="" type="radio"/> Interface	RS232

Buoy Settings

Property	Value
<input checked="" type="radio"/> Enable Off-center Correction	<input checked="" type="checkbox"/>
<input checked="" type="radio"/> Off-center XYZ (m)	0;0;0
<input checked="" type="radio"/> Enable Frequency Correction	<input checked="" type="checkbox"/>
<input checked="" type="radio"/> Correction Frequencies (Hz)	0.0333;0.05;0.1;0.15;0.2;0.2...
<input checked="" type="radio"/> Correction Factors	1;1;1;1;1;1;1;1;1;1;1;1
<input checked="" type="radio"/> Sensor Rotation Offset PRH (Deg)	0;0;0
<input checked="" type="radio"/> Enable Magnetic Declination	<input type="checkbox"/>
<input checked="" type="radio"/> Declination Angle (Deg.M)	0

External Compass Settings

Property	Value
<input checked="" type="radio"/> Enable Ext Compass Input	<input checked="" type="checkbox"/>
<input checked="" type="radio"/> Enable Ext Compass Correction	<input type="checkbox"/>
<input checked="" type="radio"/> Ext Compass Alignment Offset (Deg.M)	0.00
<input checked="" type="radio"/> Compass Type	Buoy Orientation 4164A
<input checked="" type="radio"/> Compass Warm-up Time (s)	1
<input checked="" type="radio"/> Enable Compass Power Control	<input checked="" type="checkbox"/>
<input checked="" type="radio"/> Compass Start Offset Time (s)	0
<input checked="" type="radio"/> Compass Sampling Interval (s)	300
<input checked="" type="radio"/> Compass Sample Average Number	128
<input checked="" type="radio"/> Compass Sampling Frequency (Hz)	1

AiCaP Input Parameter Heading

Property	Value
<input checked="" type="radio"/> Heading Sensor Id	Not Selected
<input checked="" type="radio"/> Heading Parameter Id	Not Available
<input checked="" type="radio"/> Heading Alignment Offset (Deg.M)	0.000
<input checked="" type="radio"/> Enable AiCaP Compass Correction	<input type="checkbox"/>

Advanced System Output/Storage

Property	Value
<input checked="" type="radio"/> Processing Time Output	Off
<input checked="" type="radio"/> FE State Parameters Output	Storage
<input checked="" type="radio"/> HW State Parameter Output	Output+Storage

< Back
Next >
Cancel

User Maintenance holds 7 different sections:

- **Mandatory**
- **Site Info**
- **Serial Port**
- **Buoy Settings**
- **External Compass Settings**
- **AiCaP Input Parameter Heading**
- **Advanced System Output /Storage**

See chapter 4.6.1 through 4.6.6 for a description of each parameter in all sections.

AiCaP Input Parameter Heading is only available when in AiCaP mode. Not visible when used in other applications.

Figure 3-16: Wave Sensor User Maintenance

3.5.1 Mandatory



Figure 3-17: Mandatory in User Maintenance

All sensors are given a **Node Description** text like Motus #xxx (xxx is the serial number of the sensor). The user can modify this node description text if required. Be aware that the node description changes to *Corrupt Configuration if it has lost the configuration in flash. Contact the factory if this happens. The configuration is saved in two sectors in flash memory. A flash sector can be corrupted if the power is lost during the saving of new configuration. The double flash sector saving ensures that it does not lose the configuration. If one of the sectors is corrupted, the other sector is used and also saved to the corrupt sector.

3.5.2 Site Info



Figure 3-18; Site Info in User Maintenance

Site Info is optional information to be entered to store information about the owner. This setting is not used in calculation.

3.5.3 Serial Port

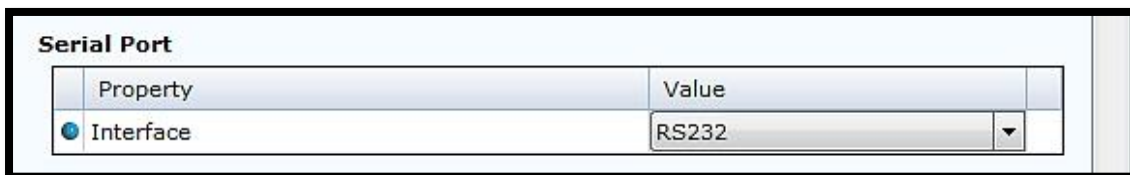

Figure 3-19: Serial Port settings in User Maintenance

The **Serial Port** group contains setting that deals with the RS-232 setup. **Interface** is only available as RS-232.

3.5.4 Buoy Settings

Property	Value
<input checked="" type="checkbox"/> Enable Off-center Correction	<input checked="" type="checkbox"/>
<input checked="" type="checkbox"/> Off-center XYZ (m)	0;0;0
<input checked="" type="checkbox"/> Enable Frequency Correction	<input checked="" type="checkbox"/>
<input checked="" type="checkbox"/> Correction Frequencies (Hz)	0.0333;0.05;0.1;0.15;0.2;0.2...
<input checked="" type="checkbox"/> Correction Factors	1;1;1;1;1;1;1;1;1;1;1;1;1;1;1
<input checked="" type="checkbox"/> Sensor Rotation Offset PRH (Deg)	0;0;0
<input type="checkbox"/> Enable Magnetic Declination	<input type="checkbox"/>
<input type="radio"/> Declination Angle (Deg.M)	0

Figure 3-20: Buoy Settings in User Maintenance

If the sensor is positioned off-center by enabling **Enable Off-center Correction** you will be able to compensate for this offset. The sensor will then use the xyz coefficients given in **Off-center XYZ (m)**. refer chapter 2.3 to calculate the off-center coefficients. Sea trials indicate that the error introduced when not compensating for this effect can be in the order of 10 -15 % (40cm installation offset) depending on the sea state and spectral distribution of the waves.

If **Enable Frequency Correction** is set then **Correction Frequencies (Hz)** and **Correction Factors** are enabled and used in calculations. **Correction Frequencies (Hz)** set a total number of 15 frequencies and each frequency has a corresponding **Correction Factor**.

Sensor Rotation Offset PRH (Deg) sets a compensation value for Pitch, Roll and Heading. These values is added to the IMU calculated Pitch, Roll and Heading. These values do not change the calculated wave direction, but only the reported Wave Sensor Orientation. When post processing the wave directions using an external compass as reference these values must be subtracted from the Sensor Orientation before the External compass corrections are performed.

Enable Magnetic Declination is normally used when sensor is used close to South Pole or North Pole. **Declination Angle (Deg.M)** is a value to correct for the magnetic variation on the site where the sensor is used. This is the angle in degrees between magnetic north and true north. Magnetic declination (variation) is the angle between the magnetic north and the true north. This angle varies depending on the position on the Earth’s surface and also varies over time. Declination is positive when magnetic north is east of true north and negative when it is to the west (input angle value $\pm 180^\circ$). Magnetic declination at the deployment location can be found for i.e. on NOAA website: <http://www.ngdc.noaa.gov/geomag-web/>

3.5.5 External Compass Settings

Property	Value
Enable Ext Compass Input	<input checked="" type="checkbox"/>
Enable Ext Compass Correction	<input type="checkbox"/>
Ext Compass Alignment Offset (Deg.M)	0.00
Compass Type	Buoy Orientation 4164A
Compass Warm-up Time (s)	1
Enable Compass Power Control	<input checked="" type="checkbox"/>
Compass Start Offset Time (s)	0
Compass Sampling Interval (s)	300
Compass Sample Average Number	128
Compass Sampling Frequency (Hz)	1

Figure 3-21: External Compass Settings in User Maintenance

To use an external compass you need to set **Enable Ext Compass Input** but to use the compass reading in calculation also the **Enable Ext Compass Correction** must be set. **Ext Compass Alignment Offset (Deg.M)** is used to compensate for a compass misalignment. The value is added to the sensor Heading.

Three different alternatives are available in **Compass Type**:

- **Buoy Orientation 4164A**
- **HSC100 NMEA**
- **Generic NMEA**

Compass Warm-up Time (s) is the time in seconds needed from power is switched on to the external compass until it is ready to output compass data. To save power the **Enable Compass Power Control** might be set. If disabled, the compass is always on. **Compass Start Offset Time (s)** is the Offset time from the start of each recording interval until the start of the external compass. Only used when **Enable Compass Power Control** is activated. **Compass Sampling Interval (s)** is the interval between each new start of the external compass sampling. This interval has to be bigger than N/f_s where N is the **Compass Sample Average Number** and f_s are the **Compass Sampling frequency**. Only used when **Enable Compass Power Control** is activated. **Compass Sample Average Number** is the number of samples to be taken from the external compass and averaged before the power to the external compass is switched off again. Selectable number of values is 4, 8, 16, 32, 64 and 128. Only used when **Enable Compass Power Control** is activated. **Compass Sampling Frequency** is the frequency which the sensor is sampling the compass, 1Hz is the only alternative yet.

3.5.6 AiCaP Input Parameter Heading

AiCaP Input Parameter Heading	
Property	Value
Heading Sensor Id	Not Selected
Heading Parameter Id	Not Available
Heading Alignment Offset (Deg.M)	0.000000E+00
Enable AiCaP Compass Correction	<input type="checkbox"/>

Figure 3-22: AiCaP Input Parameter Heading in User Maintenance

All this settings are only visible if the sensor is set to AiCaP mode and are used to control if an external AiCaP compass is connected. In the **Heading Sensor Id** a dropdown list you will find all sensors connected to the SmartGuard/SeaGuardII logger.

NOTE! Make sure you don't select the Motus as its own external compass.

In the **Heading Parameter Id** drop down list a list of all available Heading parameters with Deg.M as unit are shown. Also other directions like for example Current direction from Doppler sensors is shown if connected to the same logger. Make sure that the correct heading parameter is selected. If no external compass with less magnetic influence are in use select "**Not Selected**"

Heading Alignment Offset (Deg.M) is used to enter any misalignment in the external AiCaP compass. If **Enable AiCaP Compass Correction** is set then the value in **Heading Alignment Offset (Deg.M)** is added to the heading before it's used in calculation.

3.5.7 Advanced System Output

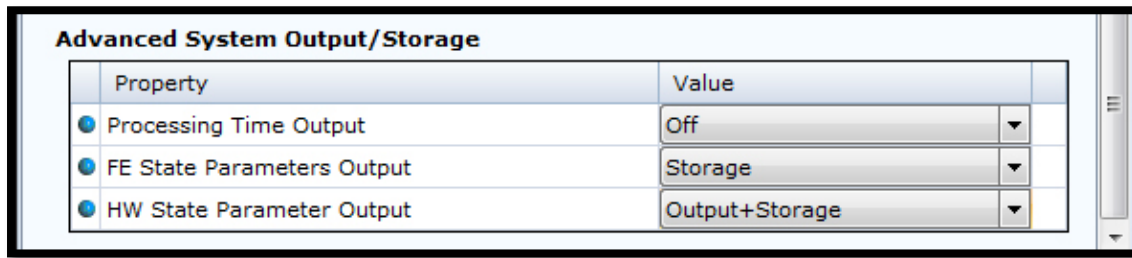

Figure 3-23: Advanced System Output in User Maintenance

The properties in this section may be set to one of the tree options: **Off**, **Storage** and **Output + Storage**.

Off: Parameter is turned off

Storage: Parameter is stored in logger but not presented on real-time output

Output + Storage: Parameter is both stored in logger and presented through the real-time output

The parameters in this section are useful parameters for troubleshooting purpose. **Processing Time Output** is the time used for processing all the data from the last wave integration time.

FE State Parameters Output is an advanced system output which can be enabled to give more information about the internal coprocessor and communication between the host processor and the coprocessor. Two output parameters, **FE State** and **FE Notifications** are controlled by this setting. The **FE State Parameter** is 0 if everything is ok. The **FE Notifications parameter** gives information about the last communications with the coprocessor.

HW State Parameter Output is an advanced system setting which can be enabled to give more information about the internal electronic hardware. The output is 0 if everything is ok.

CHAPTER 4 Stand-alone sensor configuration using AADI Real-Time Collector

This chapter describes the sensor configuration using AADI Real-Time Collector when the sensor is used stand-alone with serial communication via the PC COM-port. The sensor needs to be in AADI Real-Time mode, refer chapter 4.5.1 for changing the mode. The menus shown here are slightly different from the menus shown when the sensor is working in AiCaP mode and configured through a Datalogger via a USB connection to the PC (described in CHAPTER 3). Install and start the AADI Real-Time Collector software on your PC (license delivered with the sensor). For more info refer TD 268 AADI Real-Time Collector OM.

4.1 Establishing a new connection

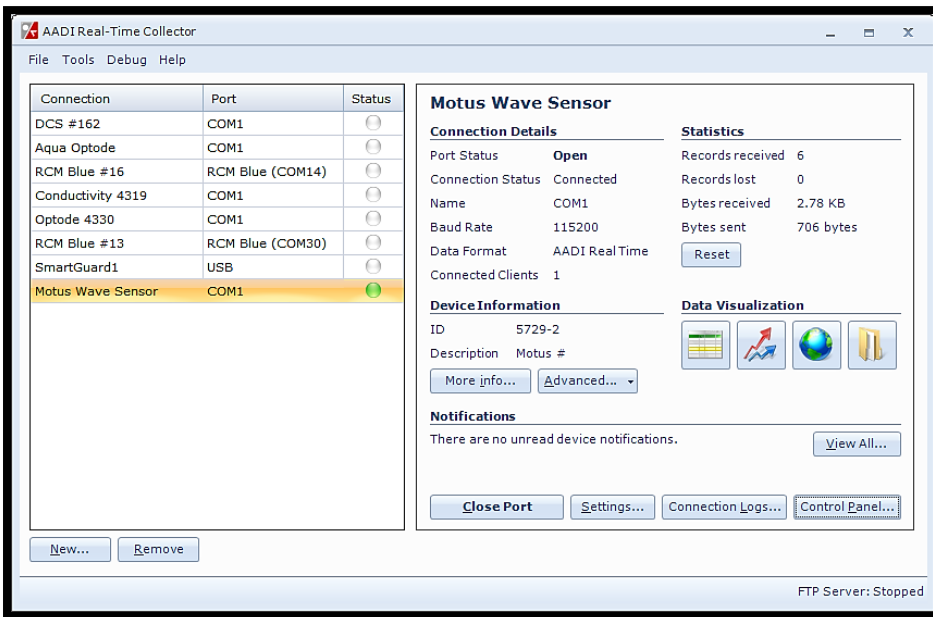

If the AADI Real-Time Collector program is being used for the first time, the connection list will be empty. Click on the **New** button in the lower left corner to create a new connection (refer Figure 4-1).

NOTE: This only needs to be done once. AADI Real-Time Collector will automatically reconnect to the sensor at next connection.

Figure 4-1: AADI Real-Time Collector start up menu

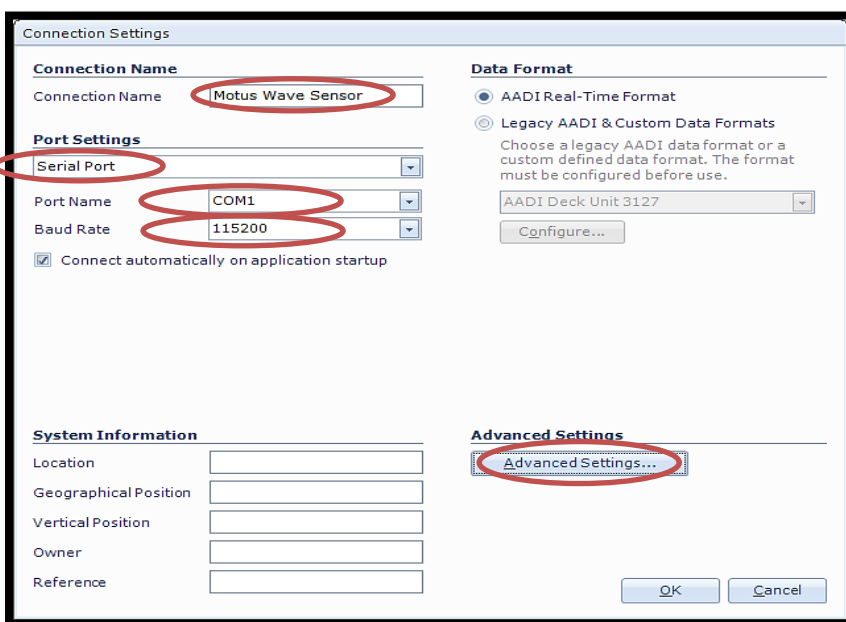

Refer Figure 4-2: Give a new **Connection Name**, choose **Serial Port**, and choose the correct COM-port on your computer. Select **115200** as baud rate. This is the default baud rate set at factory on all Motus Wave sensors.

To change the port settings you need to close the port first then click on the **Advanced Settings** down to the right and select **Connection** in the list on the left side in the **Advanced Connection Settings** window as shown in Figure 4-3

Figure 4-2: AADI Real Time Collector connection settings

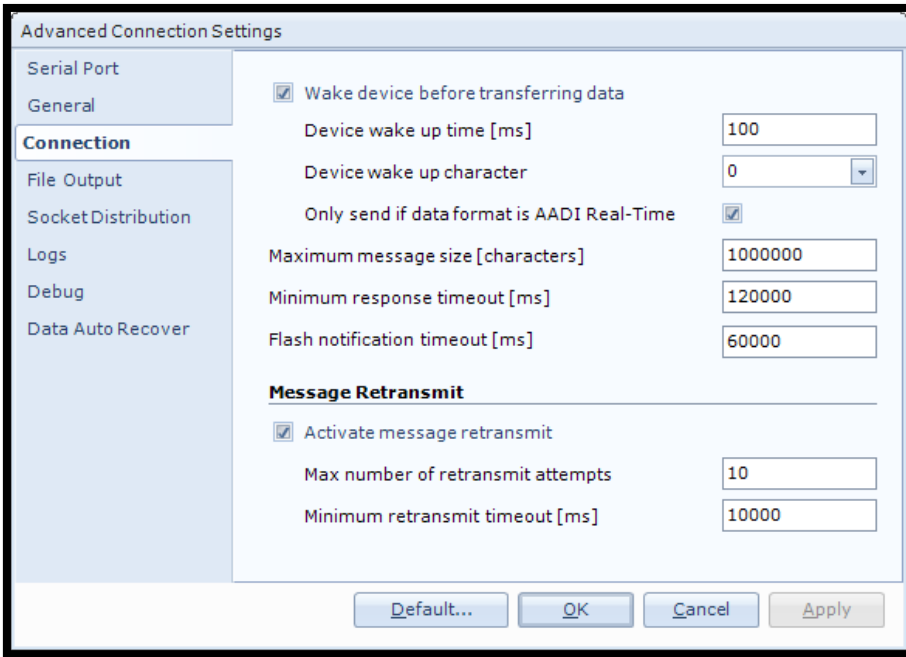

Figure 4-3: Advanced connection settings

Real-Time collector uses default settings if these are not changed. Some of the connection settings might need to be changed. The Motus Wave Sensor outputs a large number of data and can have much longer response time (depending on the configuration) than other smart sensors.

When needed changes in the **Advanced Connection Settings** have been performed, click on **Apply** and **OK** and **OK** to store the changes.

4.2 Configuration in the Control Panel

The new connection is now shown in the AADI Real-Time Collector connection list. Choose the new connection and click on the **Open Port** button (refer Figure 4-1). The status changes to green when the port is opened. Click on the **Control Panel** button in the lower right corner.

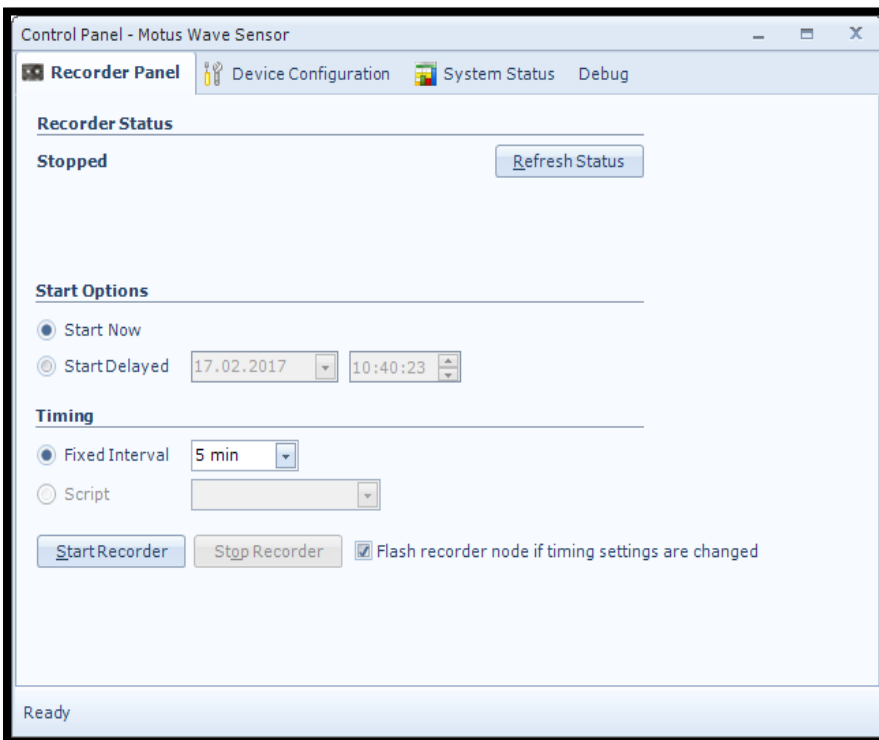

Figure 4-4: Control Panel for the Motus Wave Sensor

In the **Control Panel** window, under the **Recorder Panel**, you can start and stop recordings (refer Figure 4-4)

Click on the **Stop Recorder** button if the sensor is running as you are not allowed to configure the sensor when recording.

Under Start Option the only selectable choice is Start Now. Start Delayed is not implemented for this sensor and not able to select.

Under Timing the only selectable choice is Fixed Time where you might set the recording interval. This setting is also available in the Deployment Setting menu as interval(s), refer chapter 4.4

4.3 Device Configuration

Click on the **Device Configuration** tab in the top row of the **Control Panel** to access the sensor properties configuration.

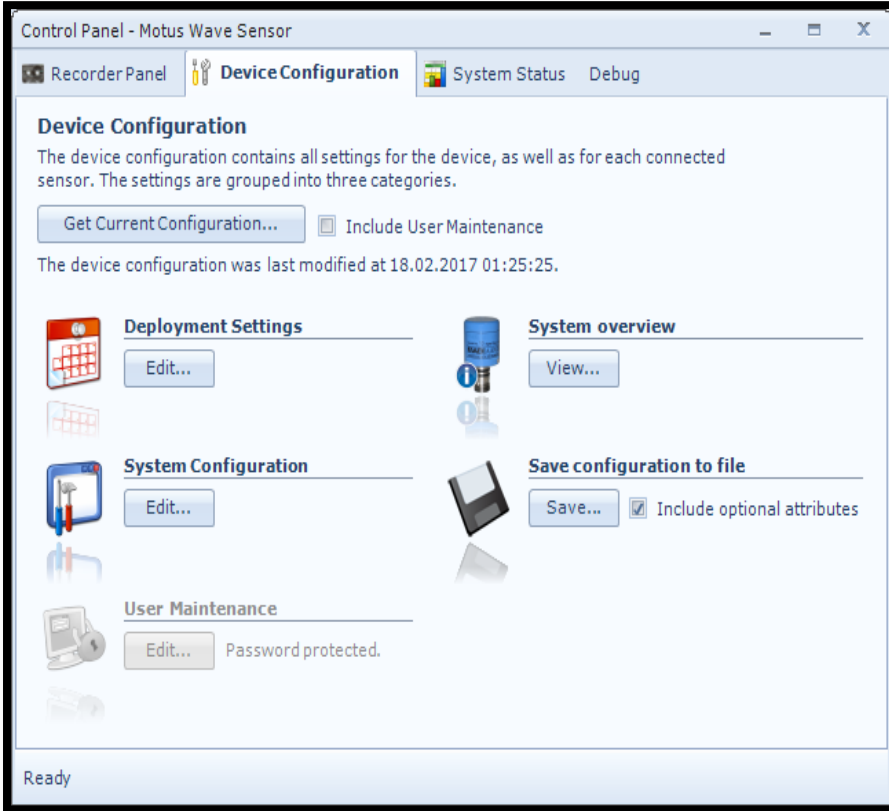

Click on **Get Current Configuration...** in order to receive the current configuration from the sensor. Check **Include User Maintenance** to view user maintenance settings. This group is password protected. **The password is 1000.**

The **Device Configuration** is separated into five sections:

- **Deployment settings**
- **System Configuration**
- **User Maintenance**
- **System overview**
- **Save configuration to file**

Figure 4-5: Device Configuration

User accessible sensor properties are found in **Deployment Settings**, **System Configuration** and **User Maintenance**. **Deployment Settings** are described in chapter 4.4, **System Configuration** is described in chapter 4.5 and **User Maintenance** is described in chapter 4.6.

To edit the configuration, click in the value-field and enter new value. Press **Next** to update sensor flash and store changes, refer chapter 3.2.2 for a full procedure. The new value is not stored before you get the confirmation from sensor.

Note! The screen shots might show minor discrepancies compared to screen shots taken from your sensor due to sensor updates. We recommend that you verify the system settings prior to starting a recording session.

4.4 Deployment Settings

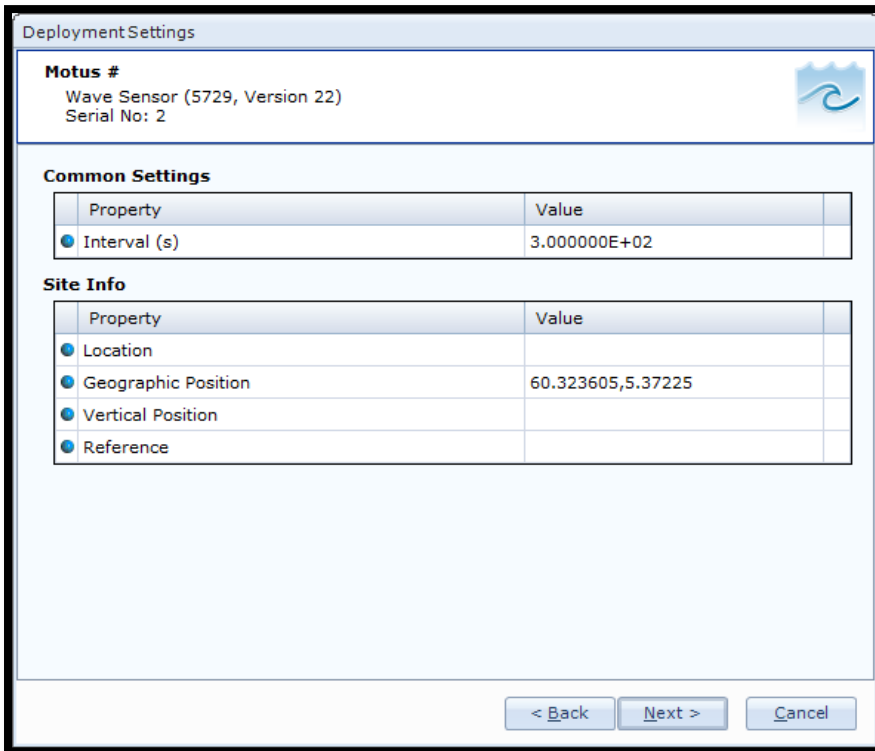

Select the **Deployment Settings** by pressing press “**Edit...**”.

This menu holds two different sections, **Common Settings** and **Site Info**.

Under **Common Settings** you will find only one property, **Interval (s)**.

This setting is used to control the sensors recording interval, the number of seconds between each output.

This setting may also be set from **Recorder Panel**. The last entered value will be the valid one if properly stored to flash.

Figure 4-6: Deployment Settings

Site Info is optional information to be entered to store information about the deployment. These setting are not used in internal calculations only stored as a part of the sensor Meta data. Geographical Position is however used to give the map coordinates to display software or post possessing software unless a GPS input is connected. The Properties under **Site Info** are:

- **Location**
- **Geographical Position**
- **Vertical Position**
- **Reference**

4.5 System Configuration

System Configuration

Motus Wave Sensor #23
 Motus Wave Sensor (5729, Version 28)
 Serial No: 23

Common Settings

Property	Value
Mode	AADI Real-Time
Enable Sleep	<input checked="" type="checkbox"/>

Terminal Protocol

Property	Value
Enable Polled Mode	<input type="checkbox"/>
Enable Text	<input checked="" type="checkbox"/>
Enable Decimalformat	<input type="checkbox"/>

Processing Dependencies

Property	Value
Water Depth (m)	2.500000E+01
Gravity (m/s^2)	9.810000E+00
High Frequency Limit (Hz)	7.000000E-01
Low Frequency Limit (Hz)	3.333000E-02
Wave Integration Time	15 min
Timeseries record length	15 min
Swell Wind Separation Frequency (Hz)	1.000000E-01
Significant Wave Height Unit	Imperial [Feet]

Output Settings

Property	Value
Mean Spreading Angle Output	Off
First Order Spread Output	Output
Long Crestedness Output	Output
Energy Spectrum Output	Output
Directional Spectrum Output	Output
Principal Dir Spectrum Output	Output
Orbital Ratio Spectrum Output	Output
Fourier Coeff Spectrum Output	Output
Wave Peak Dir Wind Output	Output
Wave Peak Dir Swell Output	Output
Wave Mean Dir Output	Output
Wave Height Swell Hm0 Output	Output
Wave Height Wind Hm0 Output	Output
Wave Height Hmax Output	Output
Wave Height Max Trough Output	Output
Wave Height Max Crest Output	Output
Wave Period Tmax Output	Output
Wave Mean Period Tz Output	Output
Wave Height H13 Output	Output
Heave Time Series Output	Output
Wave Mean Period Tm02 Output	Output
Wave Peak Period Wind Output	Output
Wave Peak Period Swell Output	Output
Heading Output	Output
External Heading Output	Output
Pitch and Roll Output	Output
System Parameters Output	Output

< Back Next > Cancel

System Configurations holds four different sections that are controlling the output from the sensor. The sections are:

- **Common Settings**
- **Terminal Protocol**
- **Processing Dependencies**
- **Output Setting**

For configuration details, refer to Chapter 4.5.1 to 4.5.4.

Refer chapter 2.5 and 2.6 for a parameter list and calculation of each parameter.

Figure 4-7: System Configuration

4.5.1 Common settings

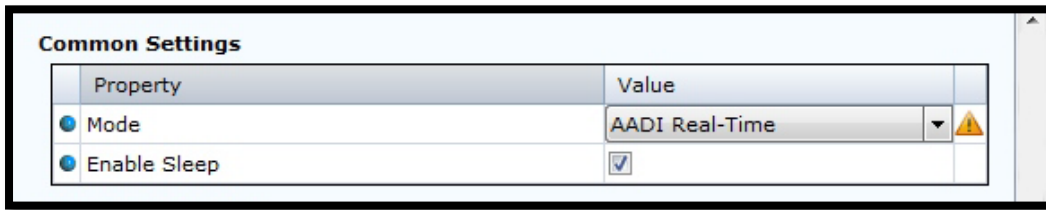

Figure 4-8: Common Settings in System Configuration

The **Common Settings** are available as shown in Figure 4-8.

Mode: The communication protocol has to be defined under “**Mode**”. There are three different choices:

- **AADi Real-Time** is the correct mode (protocol) when used together with Real-Time Collector. This is an xml based protocol which includes more metadata in the data messages.
- The **Smart Sensor Terminal** protocol is a simplified ASCII protocol which is easier to use together with a PC terminal program. This protocol is described more detailed in CHAPTER 5. It is possible to configure the sensor even if it is set to AiCaP or Smart Sensor Terminal mode when it is connected via RS-232 to the PC, but it is not possible to run and log data with Real-Time Collector unless the sensor is set to AADi Real-Time. Notice that the sensor always has to be reset when the protocol/mode has been changed.
- If the sensor is going to be used on a SeaGuardII or SmartGuard Datalogger via AiCaP, the mode has to be changed to **AiCaP** mode first and saved before connecting it to the Datalogger.

Enable Sleep: This setting gives lower power consumption in AADi Real-Time and Smart Sensor Terminal mode when the sensor is able to go to sleep between measurements. In AiCaP mode this is controlled by the logger.

4.5.2 Terminal Protocol settings

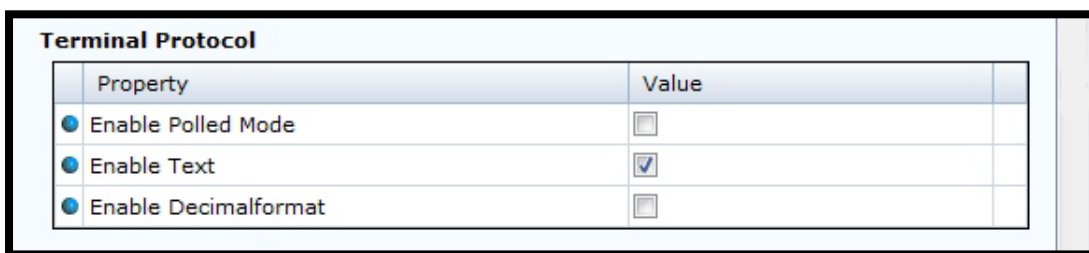
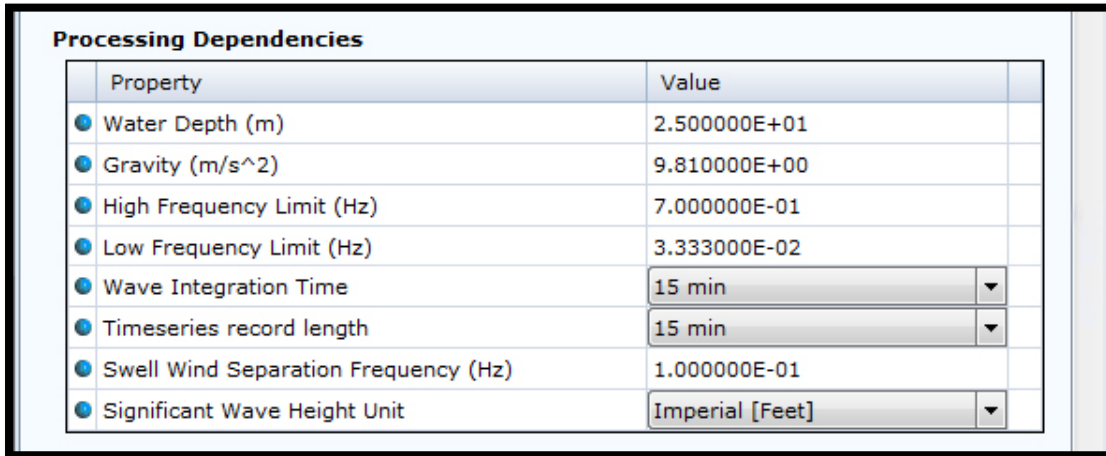

Figure 4-9: Terminal Protocol settings in System Configuration

The **Terminal Protocol** settings are available as shown in Figure 4-9 but are only used if the sensor is set to Smart Sensor Terminal protocol. See CHAPTER 5 for more details. This protocol opens up for an **Enable Polled Mode** where the sensor outputs data when the user/system polls for data (**Do Sample ()** command). **Enable Text** and **Enable Decimalformat** control the output string in Smart Sensor Terminal. With **Enable Text** enabled the sensor will put out a string with parameter name together with each reading, refer Figure 5-2 for an example where this command is toggled. **Enable Decimalformat** toggle between decimal format like 0.10 and Engineering format like 1.000E-01.

4.5.3 Processing Dependencies



Property	Value
Water Depth (m)	2.500000E+01
Gravity (m/s^2)	9.810000E+00
High Frequency Limit (Hz)	7.000000E-01
Low Frequency Limit (Hz)	3.333000E-02
Wave Integration Time	15 min
Timeseries record length	15 min
Swell Wind Separation Frequency (Hz)	1.000000E-01
Significant Wave Height Unit	Imperial [Feet]

Figure 4-10: Processing Dependencies in System Configuration

Processing Dependencies settings as shown in Figure 4-10 are settings used in the wave calculation.

Water Depth (m) is the total water depth where the buoy is located in meter. The default setting is 25 meter.

Gravity (m/s²) is the local gravity constant in m/s². The default value is 9.81m/s²

High Frequency Limit (Hz) is the lower cut-off frequency in Hz. The default value is 0.7Hz= 1/0.7 = 1.42second, this is also equal to the lowest wave period we can measure.

Low Frequency Limit (Hz) is the higher cut-off frequency in Hz. The default value is 0.03333Hz = 1/0.3333 = 30seconds. The range is maximum 33seconds = 0.03030Hz.

Wave Integration Time is the period the sensor use to calculate all wave parameters. Range is 5 minutes to 60 minutes and default is 30 minutes.

Timeseries record length is the length of each timeseries. Range is 5minutes to 60 minutes and default is 30 minutes.

Swell Wind Separation Frequency (Hz) is the frequency that separates wind from swell. Default value is 0.1Hz =10s.

Waves with period bellow 10s are then considered as wind generated sea and waves above 10s are considered as swell.

Significant Wave Height Unit is the unit used to present Significant wave height, either metric(m) or imperial(feet). The default setting is metric(m).

4.5.4 Output Settings

Output Settings	
Property	Value
● Mean Spreading Angle Output	Off ▼
● First Order Spread Output	Output ▼
● Long Crestedness Output	Output ▼
● Energy Spectrum Output	Output ▼
● Directional Spectrum Output	Output ▼
● Principal Dir Spectrum Output	Output ▼
● Orbital Ratio Spectrum Output	Output ▼
● Fourier Coeff Spectrum Output	Output ▼
● Wave Peak Dir Wind Output	Output ▼
● Wave Peak Dir Swell Output	Output ▼
● Wave Mean Dir Output	Output ▼
● Wave Height Swell Hm0 Output	Output ▼
● Wave Height Wind Hm0 Output	Output ▼
● Wave Height Hmax Output	Output ▼
● Wave Height Max Trough Output	Output ▼
● Wave Height Max Crest Output	Output ▼
● Wave Period Tmax Output	Output ▼
● Wave Mean Period Tz Output	Output ▼
● Wave Height H13 Output	Output ▼
● Heave Time Series Output	Output ▼
● Wave Mean Period Tm02 Output	Output ▼
● Wave Peak Period Wind Output	Output ▼
● Wave Peak Period Swell Output	Output ▼
● Heading Output	Output ▼
● External Heading Output	Output ▼
● Pitch and Roll Output	Output ▼
● System Parameters Output	Output ▼

Figure 4-11: Output settings in System Configuration

For a complete parameter list and description please refer to chapter 2.5 and 2.6

Depending on the Mode setting the alternative in the dropdown menu shown in Figure 4-11 will change

In **AADI Real-Time** and **Smart Sensor Terminal** the alternatives are either **Off** or **Output**.

Off: Parameter is turned off.

Output: Parameter is included in the xml or the ASCII output.

Wave Parameters in this section are:

- **Mean Spreading Angle Output**
- **First Order Spread Output**
- **Long Crestedness Output**
- **Energy Spectrum Output**
- **Directional Spectrum Output**
- **Principal Dir Spectrum Output**
- **Orbital Ratio Spectrum Output**
- **Fourier Coeff Spectrum Output**
- **Wave Peak Dir Wind Output**
- **Wave Peak Dir Swell Output**
- **Wave Mean Dir Output**
- **Wave Height Swell H_{m0} Output**
- **Wave Height Wind H_{m0} Output**
- **Wave Height H_{max} Output**
- **Wave Height Max Trough Output**
- **Wave Height Max Crest Output**
- **Wave Period T_{max} Output**
- **Wave Mean Period T_z Output**
- **Wave Height $H_{1/3}$ Output**
- **Heave Time Series Output**
- **Wave Mean Period T_{m02} Output**
- **Wave Peak Period Wind Output**
- **Wave Peak Period Swell Output**

Other non-wave parameters in this section are:

- **Heading Output** giving compass heading from the compass, Heading and StDev Heading
- **External Heading Output** giving the compass heading from an external compass if installed.
- **Pitch and Roll Output** giving pitch and roll from the internal tilt sensor. Pitch/Roll and StDev Pitch/Roll
- **System Parameters Output** giving sensor parameters: Input Voltage, Input Current and Memory Use

4.6 User Maintenance settings

User Maintenance

Motus Wave Sensor #23
 Motus Wave Sensor (5729, Version 28)
 Serial No: 23

Mandatory

Property	Value
<input checked="" type="radio"/> Node Description	Motus Wave Sensor #23

Site Info

Property	Value
<input checked="" type="radio"/> Owner	

Serial Port

Property	Value
<input checked="" type="radio"/> Interface	RS232
<input checked="" type="radio"/> Baudrate	115200
<input checked="" type="radio"/> Flow Control	Xon/Xoff
<input checked="" type="radio"/> Enable Comm Indicator	<input checked="" type="checkbox"/>
<input checked="" type="radio"/> Comm Timeout	1 min

Buoy Settings

Property	Value
<input checked="" type="radio"/> Enable Off-center Correction	<input checked="" type="checkbox"/>
<input checked="" type="radio"/> Off-center XYZ (m)	0.000000E+00;0.000000E+00...
<input checked="" type="radio"/> Enable Frequency Correction	<input type="checkbox"/>
<input checked="" type="radio"/> Correction Frequencies (Hz)	3.330000E-02;5.000000E-02;...
<input checked="" type="radio"/> Correction Factors	1.000000E+00;1.000000E+00...
<input checked="" type="radio"/> Sensor Rotation Offset PRH (Deg)	0.000000E+00;0.000000E+00...
<input checked="" type="radio"/> Enable Magnetic Declination	<input type="checkbox"/>
<input checked="" type="radio"/> Declination Angle (Deg.M)	0.000000E+00

External Compass Settings

Property	Value
<input checked="" type="radio"/> Enable Ext Compass Input	<input checked="" type="checkbox"/>
<input checked="" type="radio"/> Enable Ext Compass Correction	<input type="checkbox"/>
<input checked="" type="radio"/> Ext Compass Alignment Offset (Deg.M)	0.000000E+00
<input checked="" type="radio"/> Compass Type	Buoy Orientation 4164A
<input checked="" type="radio"/> Compass Warm-up Time (s)	1.000000E+00
<input checked="" type="radio"/> Enable Compass Power Control	<input type="checkbox"/>
<input checked="" type="radio"/> Compass Start Offset Time (s)	0
<input checked="" type="radio"/> Compass Sampling Interval (s)	300
<input checked="" type="radio"/> Compass Sample Average Number	128
<input checked="" type="radio"/> Compass Sampling Frequency (Hz)	1.000000E+00

Advanced System Output

Property	Value
<input checked="" type="radio"/> Processing Time Output	Off
<input checked="" type="radio"/> FE State Parameters Output	Output
<input checked="" type="radio"/> HW State Parameter Output	Off

< Back
Next >
Cancel

Under **User Maintenance**, you find properties that are password protected and are set/alterd by a trained user. It is not recommended to change properties unless instructed. To access this menu, check the **“Include User Maintenance”** box in the **Device Configuration** before clicking on the **“Get Current Configuration...”** button. The password is: **1000**. This menu consists of six sessions:

- **Mandatory**
- **Site Info**
- **Serial Port**
- **Buoy Settings**
- **External Compass Settings**
- **Advanced System Output**

For a full description of each property please refer to chapter 4.6.1 to 4.6.6.

Figure 4-12: User maintenance

4.6.1 Mandatory



Figure 4-13: Mandatory in User Maintenance

All sensors are given a **Node Description** text like Motus #xxx (xxx is the serial number of the sensor). The user can modify this **Node Description** text if required. Be aware that the **Node Description** changes to ***Corrupt Configuration** if it has lost the configuration in flash. Contact the factory if this happens. The configuration is saved in two sectors in flash memory. A flash sector can be corrupted if the power is lost during the saving of new configuration. The double flash sector saving ensures that it does not lose the configuration. If one of the sectors is corrupted, the other sector is used and also saved to the corrupt sector.

4.6.2 Site Info



Figure 4-14; Site Info in User Maintenance

Site Info is optional information to be entered to store information about the owner. This setting is not used in calculation.

4.6.3 Serial Port

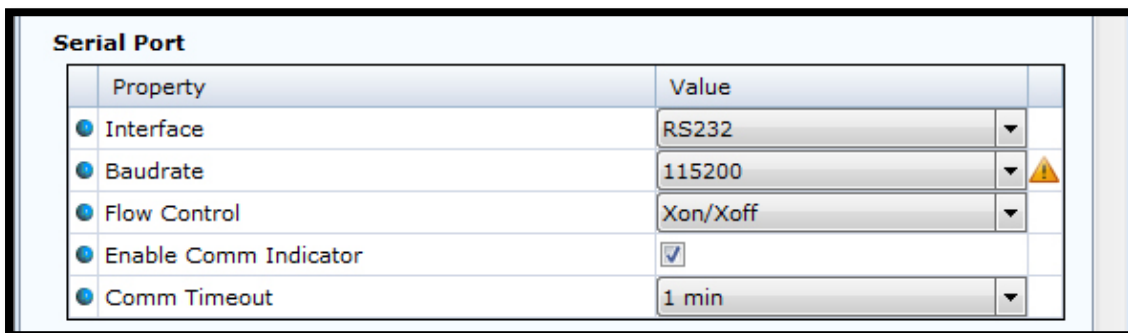

Figure 4-15: Serial Port settings in User Maintenance

The **Serial Port** group contains setting that deals with the RS-232 setup. **Interface** is only available as RS-232. When using Smart Sensor Terminal make sure that the sensor setting is the same as terminal set-up. The default setting from factory for **Baudrate** and **Flow Control** is 115200 and Xon/Xoff. **Enable Comm Indicator** is enabling communication sleep ('%') and communication ready ('!') indicators, when set to **Smart Sensor Terminal** mode. '!' indicates that the sensor is ready to communicate after sleep and '%' indicates that the sensor is going to sleep due to inactivity longer than the value/time set in **Comm Timeout**

4.6.4 Buoy Settings

Property	Value
<input checked="" type="checkbox"/> Enable Off-center Correction	<input checked="" type="checkbox"/>
<input checked="" type="checkbox"/> Off-center XYZ (m)	0.000000E+00;0.000000E+00...
<input checked="" type="checkbox"/> Enable Frequency Correction	<input type="checkbox"/>
<input type="checkbox"/> Correction Frequencies (Hz)	3.330000E-02;5.000000E-02;...
<input type="checkbox"/> Correction Factors	1.000000E+00;1.000000E+00...
<input checked="" type="checkbox"/> Sensor Rotation Offset PRH (Deg)	0.000000E+00;0.000000E+00...
<input checked="" type="checkbox"/> Enable Magnetic Declination	<input type="checkbox"/>
<input type="checkbox"/> Declination Angle (Deg.M)	0.000000E+00

Figure 4-16: Buoy Settings in User Maintenance

If the sensor is positioned off-center by enabling **Enable Off-center Correction** you will compensate for this offset. The sensor will then uses the xyz coefficients given in **Off-center XYZ (m)**, refer Figure 2-2 to calculate the off-center coefficients. Sea trials indicate that the error introduced when not compensating for this effect can be in the order of 10 -15 % (40cm installation offset) depending on the sea state and spectral distribution of the waves.

If **Enable Frequency Correction** is set then **Correction Frequencies (Hz)** and **Correction Factors** are enabled and used in calculations. **Correction Frequencies (Hz)** set a total number of 15 frequencies and each frequency has a corresponding correction factor.

Sensor Rotation Offset PRH (Deg) sets a compensation value for Pitch, Roll and Heading. These values is added to the IMU calculated Pitch, Roll and Heading. These values do not change the calculated wave direction, but only the reported Wave Sensor Orientation. When post processing the wave directions using an external compass as reference these values must be subtracted from the Sensor Orientation before the External compass corrections are performed.

Enable Magnetic Declination is normally used when sensor is used close to South Pole or North Pole. **Declination Angle (Deg.M)** is a value to correct for the magnetic variation on the site where the sensor is used. This is the angle in degrees between magnetic north and true north. Magnetic declination (variation) is the angle between the magnetic north and the true north. This angle varies depending on the position on the Earth's surface and also varies over time. Declination is positive when magnetic north is east of true north and negative when it is to the west (input angle value $\pm 180^\circ$). Magnetic declination at the deployment location can be found for i.e. on NOAA website: <http://www.ngdc.noaa.gov/geomag-web/>

4.6.5 External Compass Settings

External Compass Settings	
Property	Value
<input checked="" type="checkbox"/> Enable Ext Compass Input	<input checked="" type="checkbox"/>
<input checked="" type="checkbox"/> Enable Ext Compass Correction	<input type="checkbox"/>
<input checked="" type="checkbox"/> Ext Compass Alignment Offset (Deg.M)	0.000000E+00
<input checked="" type="checkbox"/> Compass Type	Buoy Orientation 4164A
<input checked="" type="checkbox"/> Compass Warm-up Time (s)	1.000000E+00
<input checked="" type="checkbox"/> Enable Compass Power Control	<input type="checkbox"/>
<input type="checkbox"/> Compass Start Offset Time (s)	0
<input type="checkbox"/> Compass Sampling Interval (s)	300
<input type="checkbox"/> Compass Sample Average Number	128
<input checked="" type="checkbox"/> Compass Sampling Frequency (Hz)	1.000000E+00

Figure 4-17: External Compass Settings in User Maintenance

To use an external compass you need to set **Enable Ext Compass Input** but to use the compass reading in calculation also the **Enable Ext Compass Correction** must be set. **Ext Compass Alignment Offset (Deg.M)** is used to compensate for a compass misalignment. The value is added to the sensor Heading.

Three different alternatives are available in **Compass Type**:

- **Buoy Orientation 4164A**
- **HSC100 NMEA**
- **Generic NMEA**

Compass Warm-up Time (s) is the time in seconds needed from power is switched on to the external compass until it is ready to output compass data. To save power the **Enable Compass Power Control** might be set. If disabled, the compass is always on. **Compass Start Offset Time (s)** is the Offset time from the start of each recording interval until the start of the external compass. Only used when **Enable Compass Power Control** is activated. **Compass Sampling Interval (s)** is the interval between each new start of the external compass sampling. This interval has to be bigger than N/f_s where N is the **Compass Sample Average Number** and f_s are the **Compass Sampling frequency**. Only used when **Enable Compass Power Control** is activated. **Compass Sample Average Number** is the number of samples to be taken from the external compass and averaged before the power to the external compass is switched off again. Selectable number of values is 4, 8, 16, 32, 64 and 128. Only used when **Enable Compass Power Control** is activated. **Compass Sampling Frequency** is the frequency which the sensor is sampling the compass, 1Hz is the only alternative yet.

4.6.6 Advanced System Output

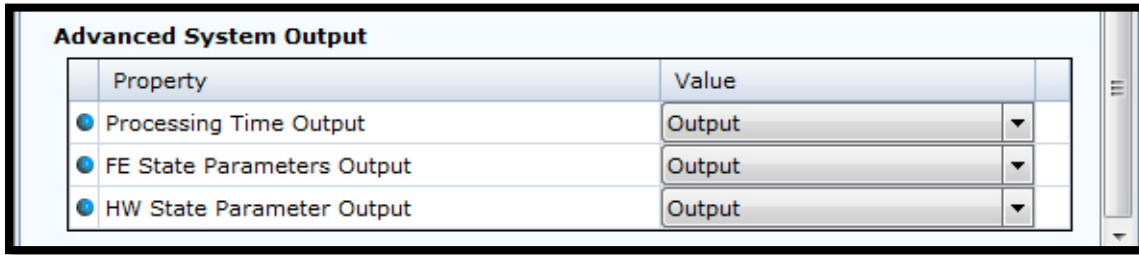

Figure 4-18: Advanced System Output in User Maintenance

In *AADI Real-Time* and *Smart Sensor Terminal* mode the alternatives are either **Off** or **Output**.

Off: Parameter is turned off.

Output: Parameter is included in the xml or the ASCII output.

The parameters in this section are useful parameters for troubleshooting purpose. **Processing Time Output** is the time used for processing all the data from the last wave integration time.

FE State Parameters Output is an advanced system output which can be enabled to give more information about the internal coprocessor and communication between the host processor and the coprocessor. Two output parameters, **FE State** and **FE Notifications** are controlled by this setting. The **FE State Parameter** is 0 if everything is ok. The **FE Notifications parameter** gives information about the last communications with the coprocessor.

HW State Parameter Output is an advanced system setting which can be enabled to give more information about the internal electronic hardware. The output is 0 if everything is ok.

4.7 Logging data on PC

The Real-Time Collector can save the incoming data to file, either to a txt-file or to xml-files. For instructions refer to Chapter 4.7.1 to 4.7.2.

4.7.1 Enabling file output

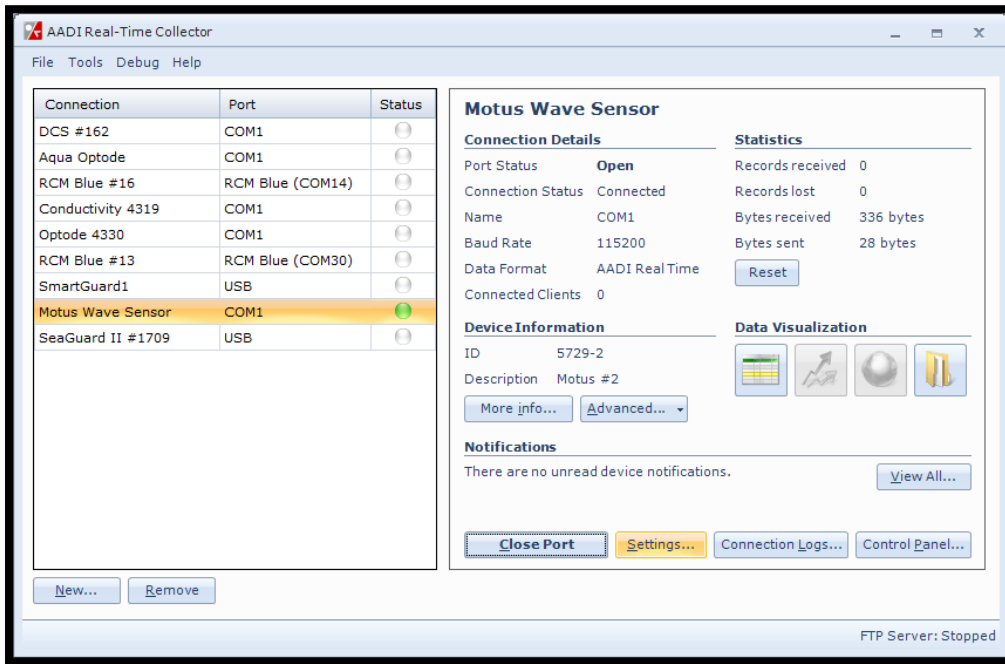

If your connection is open (, status green in the AADI Real Time Collector main menu; refer to Figure 4-19), press **Close Port** first to be able to change the file output settings. Click on the connection you are using. Click on the “**Settings...**” button, as shown in Figure 4-19.

Figure 4-19: AADI Real-Time Collector start up menu

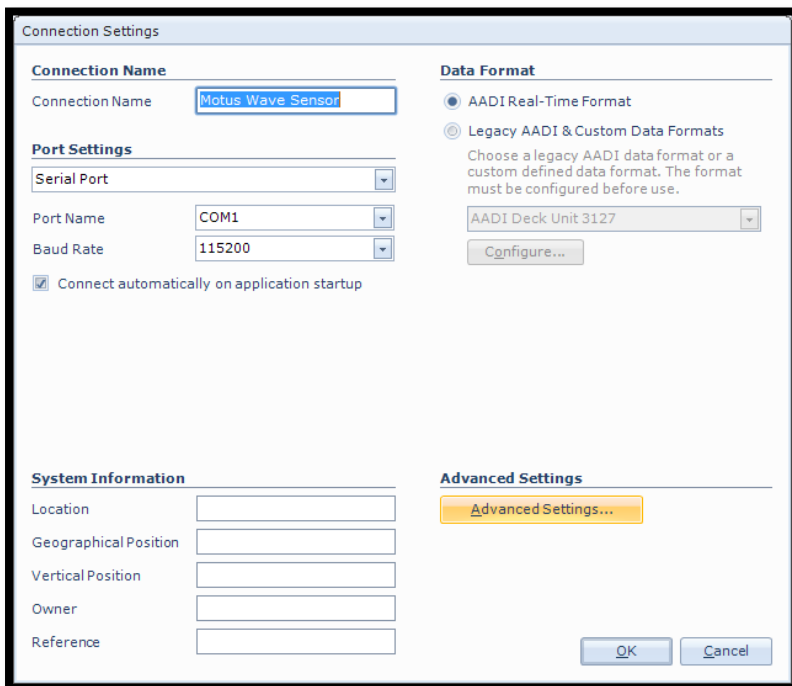

Then click on the “**Advanced Settings...**” button in the **Connection Settings** window; refer Figure 4-20.

Figure 4-20: Connection settings menu

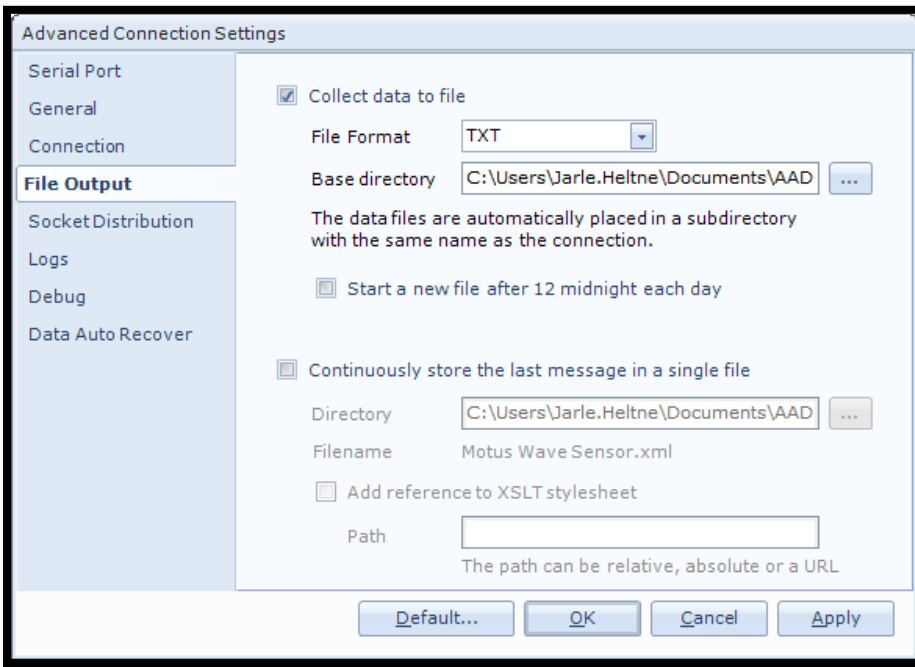

Choose **File Output** from the list on the left side. Check the **“Collect data to file”** box to enable file output. Select a file format and choose a base directory where you want the file to be saved.

Click **“OK”** in the Advanced Connection Settings window, and **“OK”** in the Connection Settings window.

Figure 4-21: Advanced connection settings / File Output

4.7.2 Starting the sensor and logging to file

In AADI Real-Time Collector start window, see Figure 4-20 click on the selected connection and **“Open Port”**. The Status turns green when the port is opened and connected. Click on the **“Control Panel...”** button in the lower right corner.

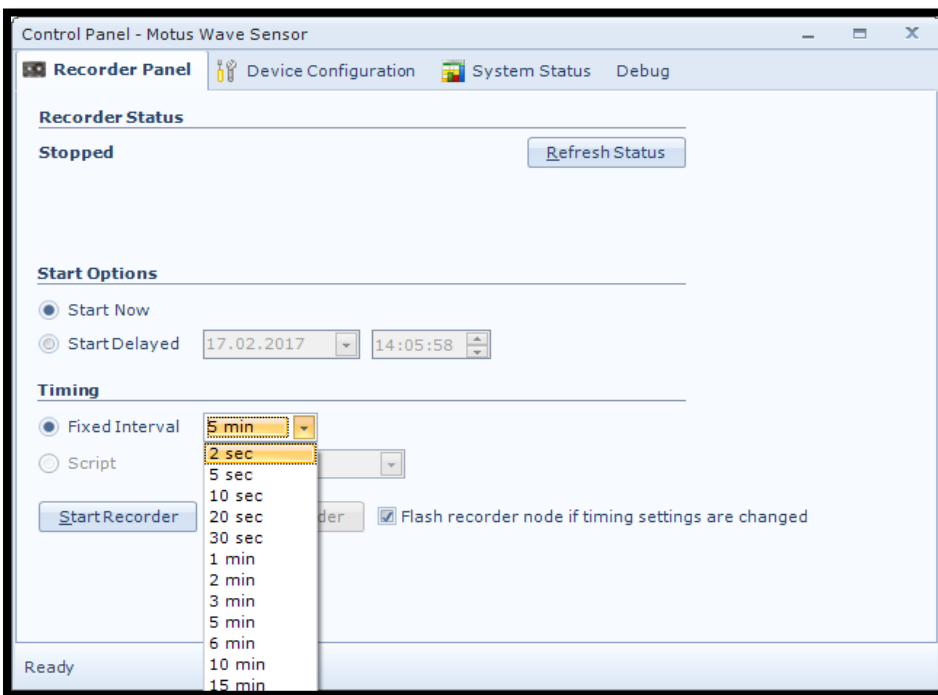

In the Control Panel you will find four alternatives:

- **Recorder Panel**
- **Device Configuration**
- **System Status**
- **Debug**

In the **Recorder Panel** window select **Start Now**, then select **Fixed Interval** and click the **“Start Recorder”** button. The shortest interval available depends on the sensor configuration.

Figure 4-22: Recorder panel

1	Description	WaveSensor #13														
2	Product Name	Motus Wave Sensor														
3	Product Number	5430														
4	Serial Number	13														
5	Device ID	5430-13														
6	Session ID	5430-13-1.5.3-0-28														
7	Location															
8	Geographic Positio	60.323605.5.37225														
9	Vertical Position															
10	Owner															
11	Reference															
12																
13																
14																
15		WaveSensor #13														
16	Record Time	Record N:	Sensor Str:	Wave Hej:	Status	Wave Pea:	Status	Wave Me:	Status	Wave Pea:	Status	Input Volt:	Status	Input Curr:	Status	Memory U
17	23.03.2017 10:29	1		0.00E+00		0.00E+00		0.00E+00		0.00E+00		9.42E+00		7.36E+01		121124
18	23.03.2017 10:29	2		0.00E+00		0.00E+00		0.00E+00		0.00E+00		9.42E+00		7.36E+01		121124
19	23.03.2017 10:30	3		0.00E+00		0.00E+00		0.00E+00		0.00E+00		9.45E+00		6.77E+01		121124
20	23.03.2017 10:30	4		0.00E+00		0.00E+00		0.00E+00		0.00E+00		9.45E+00		6.69E+01		121124
21	23.03.2017 10:31	5		0.00E+00		0.00E+00		0.00E+00		0.00E+00		9.44E+00		6.65E+01		121124
22	23.03.2017 10:31	6		0.00E+00		0.00E+00		0.00E+00		0.00E+00		9.45E+00		6.69E+01		121124
23	23.03.2017 10:32	7		0.00E+00		0.00E+00		0.00E+00		0.00E+00		9.45E+00		6.72E+01		121124
24	23.03.2017 10:32	8		0.00E+00		0.00E+00		0.00E+00		0.00E+00		9.44E+00		6.66E+01		121124
25	23.03.2017 10:33	9		0.00E+00		0.00E+00		0.00E+00		0.00E+00		9.45E+00		6.69E+01		121124
26	23.03.2017 10:34	10		0.00E+00		0.00E+00		0.00E+00		0.00E+00		9.45E+00		6.67E+01		121124
27	23.03.2017 10:34	11		0.00E+00		0.00E+00		0.00E+00		0.00E+00		9.45E+00		6.64E+01		121124
28	23.03.2017 10:34	12		0.00E+00		0.00E+00		0.00E+00		0.00E+00		9.44E+00		6.71E+01		121124
29	23.03.2017 10:35	13		0.00E+00		0.00E+00		0.00E+00		0.00E+00		9.44E+00		6.62E+01		121124

Data will start logging in the defined directory. If it is a txt-file, the easiest way to view it is in Excel. Figure 4-23 gives an example of obtained data file. The different parameters are organized in columns.

Figure 4-23: Example of a txt-file obtained from the sensor using RT Collector

4.8 Viewing incoming data in real-time

When the sensor is running, the incoming data can be viewed under “**Connection Logs...**” in the main AADI Real-Time Collector menu (refer Figure 4-19 and Figure 4-24).

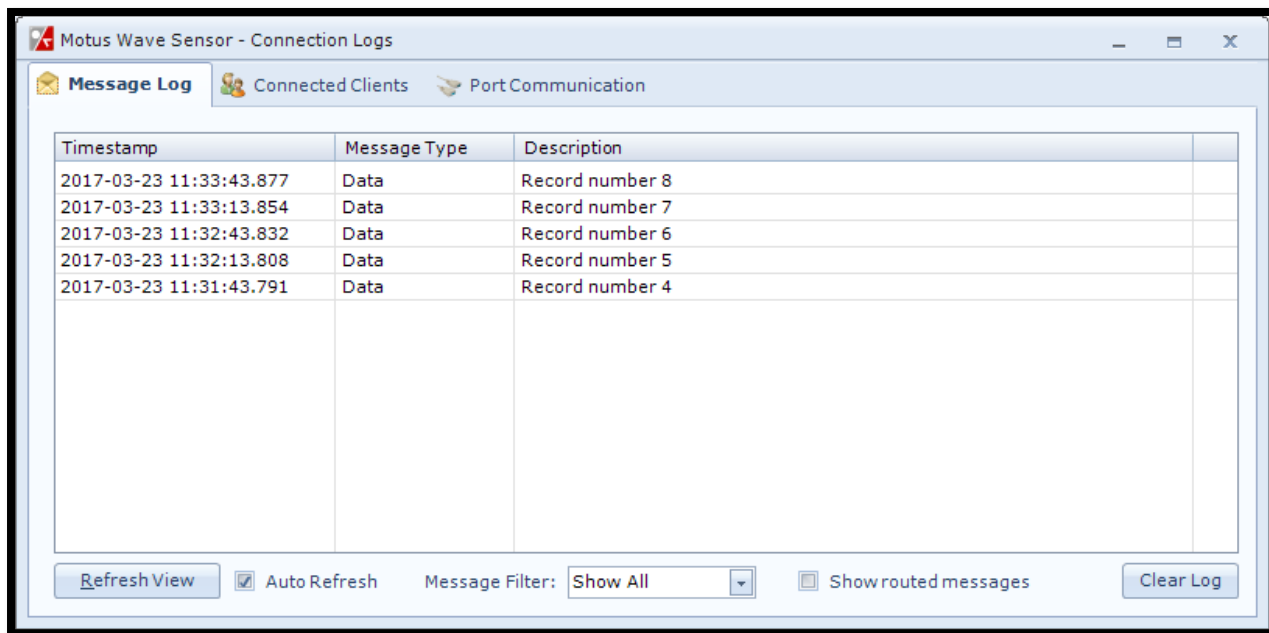

Figure 4-24: Connection Logs

Double-click on one of the Record numbers to look at the data.

Click on the + signs to open and see all the data in the message.

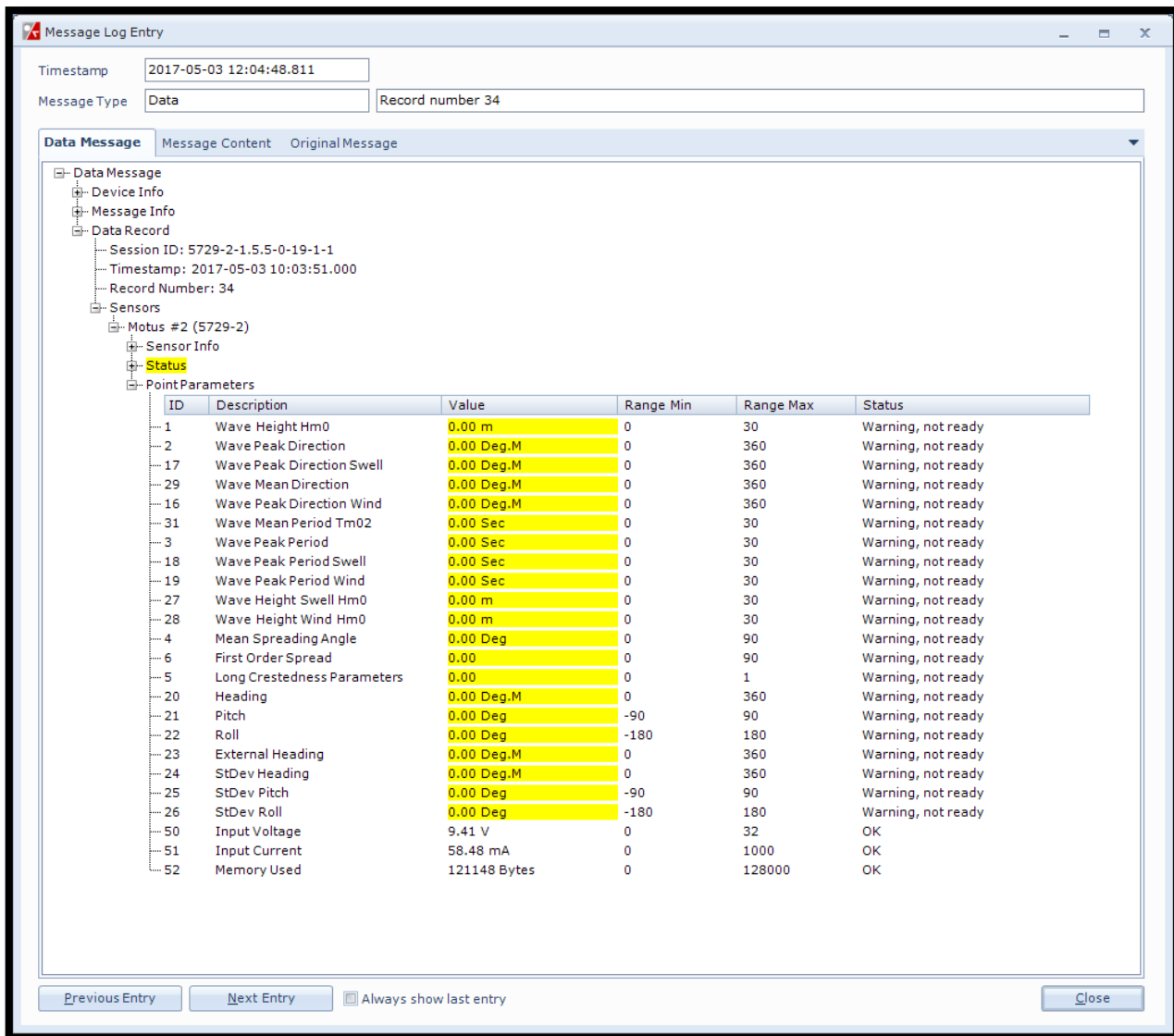

Figure 4-25: Visualization of incoming data from the sensor in real time

Previous records or newer records (Figure 4-25) can be viewed by clicking on **Previous Entry** button or **Next Entry** button. An automatic update to the last data message can be enabled by checking the Always show last entry check box.

The original message content can be seen if clicking on the **Original Message** tab.

CHAPTER 5 Sensor configuration using Smart Sensor Terminal protocol

This chapter describes how to communicate with the Motus Wave Sensor using the RS-232 Smart Sensor Terminal protocol.

5.1 Communication setup

The 5729 Motus Wave Sensor can be used on a SmartGuard or SeaGuardII (AiCaP) Dataloggers or connected to a RS-232 com-port (PC or other devices with RS232 com-port).

Most terminal programs can be used for **Smart Sensor Terminal** communication with the sensor when connected to a PC, e.g. Teraterm.

The following Smart Sensor Terminal setup should be used:

- 115200 Baud
- 8 Data bits
- 1 Stop bit
- No Parity
- Xon/Xoff Flow Control

IMPORTANT! *The terminal program must send a Line Feed after each Carriage Return.*

5.2 Sensor startup

When property **Enable Text** is set to **Yes**, **StartupInfo** is displayed at sensor power up or after reset. **StartupInfo** contains information about product number, serial number, current mode setting, Protocol version for Smart Sensor Terminal operation and Config Version (Refer to Figure 5-1).

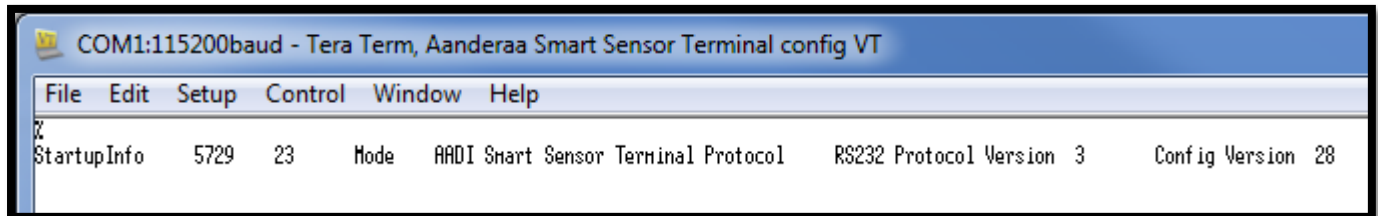

Figure 5-1: Start up info: communication using Tera Term

In order to minimize the current drain the sensor normally enters a power down mode after each sampling; the sensor can be awake by any characters on the Smart Sensor Terminal input, and will stay awake for a time set by the **Comm TimeOut** property after receiving the last character.

If the property **Comm TimeOut** is set to other than '**Always On**' the serial interface will not be activated after power-up (or the **Reset** command). Any character will activate the serial interface, but a Carriage Return (CR or CR+LF), '/' or ';' are often preferred since these characters do not interfere with the command syntax. The serial interface will then be active until a period of input inactivity specified by the **Comm TimeOut** value (10 s, 20 s, 30 s, 1 min, 2 min, 5 min, 10 min). The **Communication Sleep Indicator**, '%', will be transmitted when the serial communication is deactivated, and the **Communication Ready Indicator**, '!', is outputted subsequent to activation (electronics require up to 500ms start up time). When **Comm TimeOut** is set to '**Always On**' the communication (and microprocessor) will be kept active all time.

The **Communication Sleep Indicator** '%' and the **Communication Ready Indicator** '!' are not followed by Carriage Return and Line Feed.

Any character will cause the electronics to return to normal operation; when the sensor has responded with the character '!', new commands may be entered.

When communicating with the sensor, you must start by pressing **Enter**. The sensor will respond in two ways (**Comm TimeOut** is 1 minute by default in the following description):

- If the sensor is ready for communication, it will not send any response indicator. The sensor will stay awake and ready to receive commands for 1 minute (controlled by the **Comm TimeOut**) since the last command.
- If the sensor is in sleep mode and not ready for communication, the sensor will send a **Communication Ready indicator** (!) when awakened (within 500ms). The sensor will then be ready for communication.

5.3 Description of protocol

All inputs to the sensor are given as commands with the following format:

- **MainCmd SubCmd** or **MainCmd Property(Value, ..., Value)**

Description of ASCII coded communication rules:

- The main command, **MainCmd**, is followed by an optional subcommand (**SubCmd**) or sensor property (**Property**).
- The **MainCmd** and the **SubCmd/Property** must be separated with the space ' ' character.
- When entering new settings the **Property** is followed by a parenthesis containing comma-separated values.
- The command string must be terminated by Carriage Return and Line Feed (ASCII code 13 & 10).
- The command string is not case sensitive (UPPER/lower-case).
- The ENUM property settings are case sensitive. E.g. "**Set Mode(AiCaP)**" Here AICAP will result in argument error. Refer Table 1-3.
- A valid command string is acknowledged with the character '#' while character '*' indicates an error. Both are followed by Carriage Return/ Line Feed (CRLF).
- For most errors a short error message is also given subsequent to the error indicator.
- There are also special commands with short names and dedicated tasks, as **save**, **reset**, and **help**.
- All names and numbers are separated by tabulator spacing (ASCII code 9).
- The string is terminated by Carriage Return and Line Feed (ASCII code 13 & 10).

Note! Losing power during the flashing process can cause corruption of vital settings, such as coefficients, serial number, model number etc. If losing settings, contact AADI Service department for new setting file for the specific sensor with further instructions.

5.3.1 Passkey for write protection

To avoid accidental change, most of the properties are write-protected. There are four levels of access protection, refer Table 5-1.

A special property called **Passkey** must be set according to the protection level before changing the value of properties that are write-protected. After a period of inactivity at the serial input, the access level will revert to default. This period corresponds to the **Comm TimeOut** setting, or 1 minutes if the **Comm TimeOut** is set to **Always On**.

Output	Passkey	Description
No		No Passkey needed for changing property
Low	1	The Passkey must be set to 1 prior to changing property
High	1000	The Passkey must be set to 1000 prior to changing property This Passkey value also gives read access to factory properties that usually are hidden
Read Only		The user have only read access

Table 5-1: Passkey protection

5.3.2 Save and Reset

When the required properties are set, you should send a **Save** command to make sure that the new configuration is saved internally in the flash memory. The sensor always reads the configuration from the internal flash memory after reset and power up. The **Save** command takes about 20 seconds to complete (indicated with the character '#').

Always send a **Reset** command when a new configuration has been saved (or switch the power OFF and then back ON), or else calculated parameters may be corrupted. This forces the sensor to start up with the new configuration input. If the **Enable Sleep** property is set to **Yes** and the **Comm TimeOut** property is not set to **Always On** the sensor enters sleep mode after reset.

At startup/reset the sensor performs measurements according to the interval setting if the mode is **Smart Sensor Terminal**. If **Enable Text** is set to **Yes**, the **Startup Info** is presented.

If the **Save** command is executed the new setting will be stored in the internal Flash memory.

Property changes will be lost when the sensor is reset or loses power unless you type the **Save** command.

Refer to Figure 5-2. The number of parameters in the list depends on which parameters are enabled.

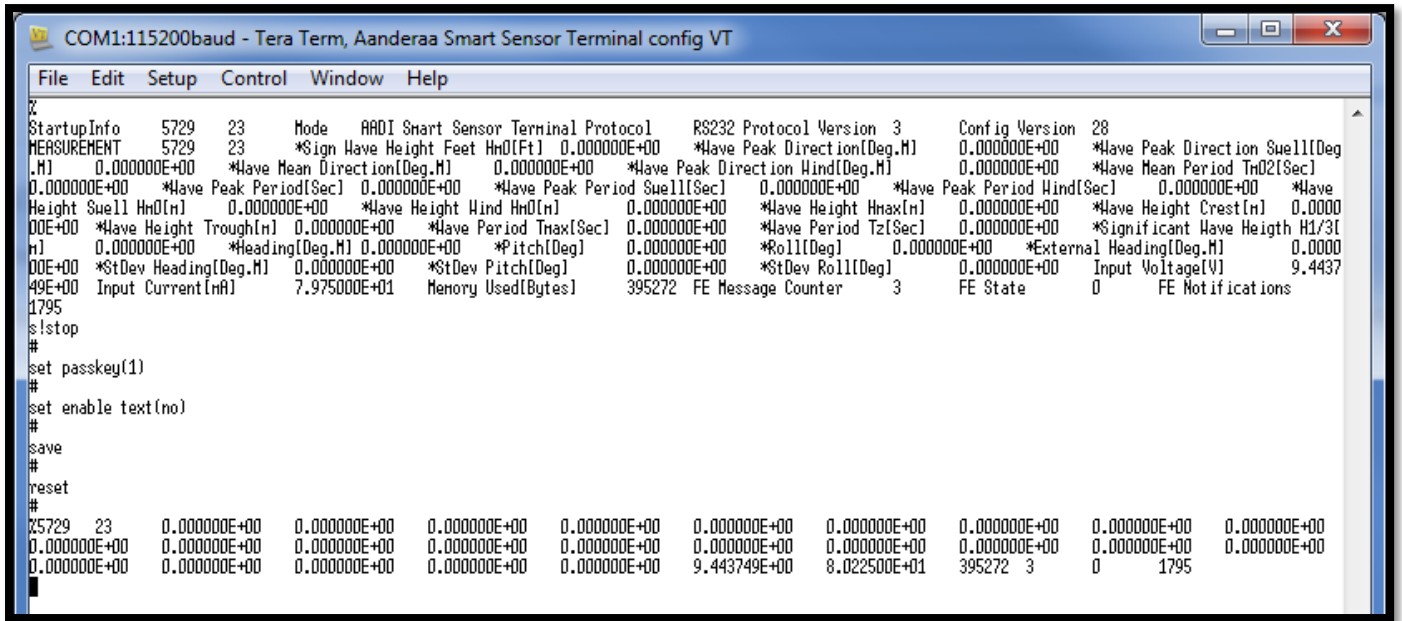

Figure 5-2: Save and reset in Tera Term

5.3.3 Available commands

Available commands and properties for the sensors are given in Table 5-2 and Table 1-3 respectively.

Table 5-2 Available RS-232 commands.

Command	Description
Start	Start a measurement sequence according to current configuration
Stop	Stop a measurement sequence
Do Sample	Calculates and presents a new single set of measurement data. (used in polled mode).
Do Output	Presents the last set of calculated measurement data (normally only used in polled mode).
Get <i>ConfigXML</i>	Outputs information about the configuration properties in XML format
Get <i>DataXML</i>	Outputs information about available(enabled) parameters in XML format
Get <i>Property</i>	Output Property value (refer table 1-1), e.g get interval.
Get All	Output information about the configuration properties (same as shown on Get ConfigXML but without all the metadata)
Get All Parameters	Output information about all parameters value

Set <i>Property(Value,..., Value)</i>	Set Property to Value,..., Value (refer table 1-1), eg set interval(60)
Set <i>Passkey(Value)</i>	Set passkey to change access level
Save	Store current settings
Load	Reloads previous stored settings
Reset	Resets the sensor with last saved new configuration
Help	Print help information
;	Comment string, following characters are ignored
//	Comment string, following characters are ignored

5.3.4 The Get command

The **Get** command is used to read the value/values of a property and to read the latest value of a parameter.

The command name **Get** followed by a **Property** returns a string in the following format:

Property ProductNo SerialNo Value, ..., Value

The string starts with the name of the property, the product number and serial number of the sensor, and finally the value of the property.

The command name **Get** followed by a parameter returns the name and unit of the parameter, the product and serial number of the sensor, and finally the latest parameter reading.

A special version, **Get All**, reads out all available properties in the sensor. Some properties are passkey protected and will not be shown without first writing the passkey. To see all user accessible properties, use **passkey(1000)**.

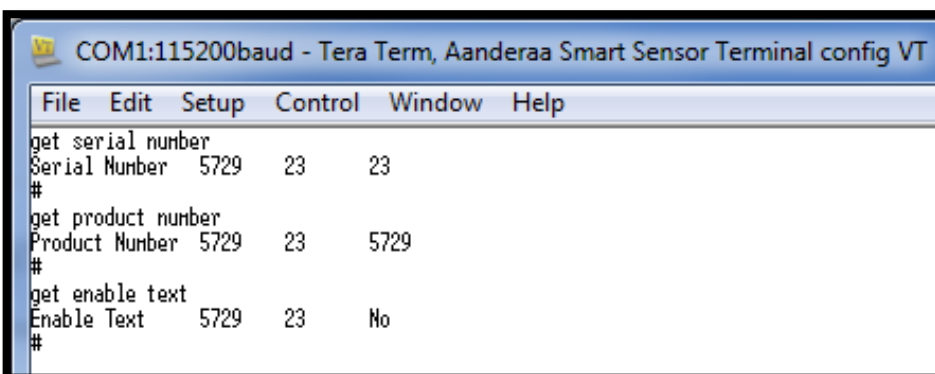
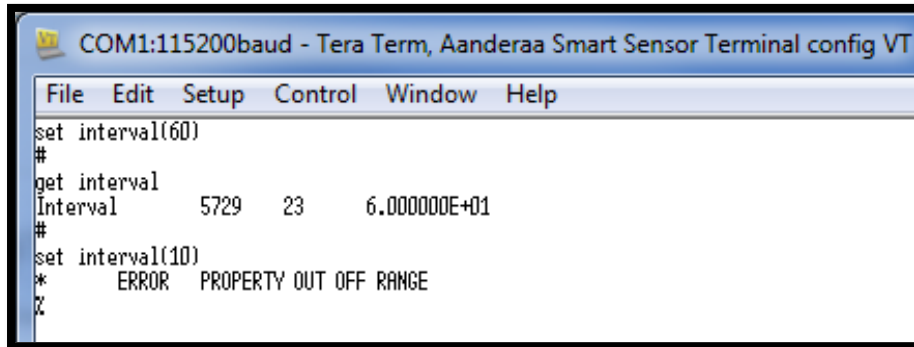

Figure 5-3: The Get Command

5.3.5 The Set command

The **Set** command is used for changing a property. The corresponding **Get** command can be used to verify the new setting, as shown in Figure 5-4. Please note depending on the configuration a too short interval will give an error message.



```

COM1:115200baud - Tera Term, Aanderaa Smart Sensor Terminal config VT
File Edit Setup Control Window Help
set interval(60)
#
get interval
Interval      5729  23  6.000000E+01
#
set interval(10)
* ERROR PROPERTY OUT OFF RANGE
%
  
```

Figure 5-4: The Set Command

Use the **Save** commands to permanently store the new property value. Remember to always wait for the acknowledge character '#' after a save before switching off power to the sensor. If the power is lost while saving, the previous configuration saved to flash is used by the sensor.

The **Mode** and **Baudrate** property will require a **Reset** before the change is executed. All other property changes will be executed immediately.

Some properties are passkey protected and will not be accessible without first writing the passkey. If the passkey is needed you get the error message: **"ERROR PROTECTED PROPERTY"**. Using **passkey 1000** opens up all user accessible property settings. Refer Table 5-1 for more info

5.3.6 XML commands

The **Get ConfigXML** command outputs all available sensor properties in XML-format.

The **Get DataXML** command outputs all available sensor parameters in XML-format.

The **XML-output** is a general format shared by all Aanderaa smart sensors; the output from different types of smart sensors can be read and presented as e.g. in a general smart sensor setup program.

The output from the **Help** command is shown in the Figure 5-5.

```

COM1:115200baud - Tera Term, Aanderaa Smart Sensor Terminal config VT
File Edit Setup Control Window Help
help
#
Commands:      Do_SUBCMD<CRLF>          = Execute SUBCMD
               Get_PROPERTY<CRLF>      = Output PROPERTY value.
               Get_ALL<CRLF>           = Output all property values.
               Get_ALL Parameters<CRLF> = Output all parameter values.
               Set_PROPERTY(V,..V)<CRLF> = Set PROPERTY to V,..V.
               Set_Passkey(V)<CRLF>     = Set Passkey.
               Save<CRLF>              = Store current settings.
               Load<CRLF>             = Load stored settings.
               Reset<CRLF>            = Reset node.
               Stop<CRLF>             = Stop measurement
               Start<CRLF>           = Start measurement
               Help<CRLF>            = Print help information.

Sub commands:  Sample
               Output
               Set Clock
               Get Clock

Argument list for enumerated properties:
Interface:     RS232
Baudrate:     4800,9600,57600,115200
Flow Control:  None,Xon/Xoff
Comm Timeout:  Always On,10 s,20 s,30 s,1 min,2 min,5 min,10 min
Compass Type:  Buoy Orientation 4164A,HSC100 NMEA,Generic NMEA
Compass Sample Average Number: 4,8,16,32,64,128
Processing Time Output: Off,Output
FE State Parameters Output: Off,Output
HW State Parameter Output: Off,Output
Mode:         AiCaP,Smart Sensor Terminal,AADI Real-Time
Wave Integration Time: 5 min,10 min,15 min,20 min,25 min,30 min,35 min,40 min,45 min,50 min,55 min,1 hour
Timeseries record length: 5 min,10 min,15 min,20 min,25 min,30 min,35 min,40 min,45 min,50 min,55 min,1 hour
Significant Wave Height Unit: Metric [m],Imperial [Feet]
Mean Spreading Angle Output: Off,Output
First Order Spread Output: Off,Output
Long Crestedness Output: Off,Output
Energy Spectrum Output: Off,Output
Directional Spectrum Output: Off,Output
Principal Dir Spectrum Output: Off,Output
Orbital Ratio Spectrum Output: Off,Output
Fourier Coeff Spectrum Output: Off,Output
Wave Peak Dir Wind Output: Off,Output
Wave Peak Dir Swell Output: Off,Output
Wave Mean Dir Output: Off,Output
Wave Height Swell Hm0 Output: Off,Output
Wave Height Wind Hm0 Output: Off,Output
Wave Height Hmax Output: Off,Output
Wave Height Max Trough Output: Off,Output
Wave Height Max Crest Output: Off,Output
Wave Period Tmax Output: Off,Output
Wave Mean Period Tz Output: Off,Output
Wave Height H13 Output: Off,Output
Heave Time Series Output: Off,Output
Wave Mean Period Tm02 Output: Off,Output
Wave Peak Period Wind Output: Off,Output
Wave Peak Period Swell Output: Off,Output
Heading Output: Off,Output
External Heading Output: Off,Output
Pitch and Roll Output: Off,Output
System Parameters Output: Off,Output
#

```

Figure 5-5: Output example from the Help command

CHAPTER 6 Use of External Compass

6.1 General information

An important input parameter for calculation of wave parameters is the heading information. If the magnetic distortion at the location where the sensor is to be installed is too large the heading should be provided by an external compass placed at an undistorted location, for instance in the mast.

In a system with SmartGuard or SeaGuardII logger the external compass can be connected directly to the logger or directly to the wave sensor:

- External compass connected directly to sensor:
 - The wave sensor has a separate connector for connection of external compass. When properly configured the sensor will power up the external compass and receive heading information at preset intervals. Refer to chapter 3.5.5 when controlled via logger or chapter 4.6.5, when used as stand-alone sensor, for detailed information on how to configure the sensor for connection of external compass.
 - Both the Aanderaa Buoy Orientation sensor 4164A and general NMEA 183 (“HDG” output sentence) compliant compasses are supported. A special configuration option is provided for the HSC100 compass from Digital Yacht. By using this option no setup of the compass itself will be required.
 - When an external compass is connected directly to the sensor and the wave sensor is connected to SmartGuard via AiCaP bus the external compass heading information can be distributed to other AiCaP sensors in the system.
- External compass reading input from SmartGuard or SeaGuardII.
 - In cases where the buoy is equipped with sensors giving heading information directly to the logger the heading information can be distributed by the logger to other sensors connected to the AiCaP bus. This feature enables the wave sensor to receive heading information from other connected sensor in the system via SmartGuard or SeaGuardII.

When using an external compass the orientation angle between the wave sensor and the compass must be taken into account. This angle must be set in the ***Ext Compass Alignment Offset (Deg.M)*** - property in the sensor configuration. By default this is set to zero which means that if the external compass can be aligned to the orientation arrow of the wave sensor the direction will be correct. A self-leveling crossline laser might be a god tool for aligning the two sensors. If the installation does not allow for alignment, the angle between the sensors should be measured and the ***External Compass Offset*** updated accordingly.

For cable assembly refer to chapter 9.2 in this document.

6.2 External compass types

6.2.1 Buoy Orientation 4164A

- Buoy Orientation sensor. Aanderaa part no: 4164A.



Figure 6-1: Aanderaa Buoy Orientation Sensor 4164A

- Mounting Bracket:
 - Sensor outlet. Aanderaa part no: 3964816: Drawing DID-50903.
 - Sensor orientation pin. Aanderaa part no: 3962116. Drawing V-5947.

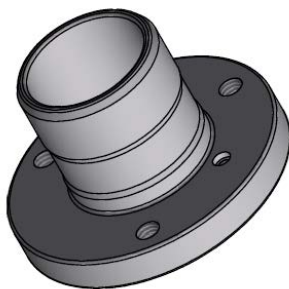

Figure 6-2: Mounting Bracket

- Connecting cables:
 - Aanderaa part number 5548M. 10 pin plug to 9 pin D-sub. Length 5m
 - Aanderaa part no: 3485M. 10 pin plug - free end. Length 5m.
 - Link cable between SmartGuard serial port and sensor cable.
- Data output (RS-232):
 - One line, TAB separated fields, Pitch, Roll, Heading
 - Baud rate: 9600 , 8N1

6.2.2 HSC 100-NMEA

- Digital Yacht HSC100 Compass sensor



Figure 6-3: Digital Yacht HSC100

- Mounting Bracket:
 - Included in delivery of compass sensor.
- Connecting cable:
 - Supplied with a 15-meter cable.
 - Link cable between SmartGuard serial port and sensor cable.
- Data output (RS-232):
 - NMEA0183 sentence 'HDG' (Magnetic Heading).
 - Baud rate: 4800 , 8N1

CHAPTER 7 Electro Magnetic Compatibility and Cables

In order for a manufacturer to legally produce and sell a product, it has to apply for CE marking. This means that the commercialized product is conform to the CE applicable standards and can freely circulate within the EFTA (European Free Trade Association) & European Union countries. The applicable directive for the Motus wave sensor is the EU EMC 89/336/EMC (all electrical and electronic appliances) which mainly focus on the electromagnetic disturbances the sensor can generate, which should not exceed a level allowing radio and telecommunication equipment to operate as intended, and that the sensor has an adequate level of intrinsic immunity to electromagnetic disturbance to be able to operate as intended.

This chapter describes the requirements for the Electromagnetic Compatibility (EMC) of the sensor. . And also addresses the different cables available for use with the sensor.

7.1 EMC Testing

The Motus wave sensor has been tested at an accredited test laboratory to verify that the sensor fulfills the requirements in the EU EMC directive (89/336/EMC).

Applied standards

- EN 55011 (2009)+A1
- EN 61326-1 (2013)

Applied tests

- Conducted Emissions
- Electrostatic Discharge Immunity
- Surge Immunity
- Conducted RF Disturbance Immunity

7.2 Cables

Different cables are available for stand-alone use with free end and connectors. The cables have both power and signal lines RS-232. See chapter 9.2 for more information on cables that is best suited for use in the actual application. When delivered, system drawings/cable drawings give details on parts connection and installation overview with best EMC performance (best noise and surge immunity).

7.3 Power – Voltage range

The input voltage range is from 6 to 30Vdc. When using long cables the voltage should be as close to 30V as possible. The peak current while the sensor is measuring (after power on) is normally well below, but it varies dependent on how high the input voltage is and how large the voltage drop is in the cable (lower voltage on the sensor gives higher peak current).

CHAPTER 8 Maintenance

With 50 years of instruments design and production for the scientific community, in use around the world, you can count on our reputation for designing the most reliable products available.

We are guided by three underlying principles: quality, service, and commitment. We take these principles seriously, as they form the foundation upon which we provide lasting value to our customers. Our unmatched quality is based on a relentless program of continuous monitoring to maintain the highest standards of reliability.

8.1 General

In order to assure the quality of this sensor, critical properties are tested during production. A special form, named 'Test and Specification Sheet' (delivered with the sensor) lists the tests and their results and checkpoints.

As this sensor is normally installed above water and inside cabinets it requires very little maintenance. Only cleaning and check of mounting brackets connectors and cables should be necessary.

8.2 Retrieval of the sensor

Clean the Sensor after each deployment if necessary.

The sensor housing will tolerate most cleaning agents. Often 30% Hydrochloric acid (HCL) (Muriatic acid) or acetic acid will be useful for removing barnacles and similar fouling.

Be sure to follow the safety precaution for such acids.

When removing or disconnecting the sensor from attached cables always protect connectors on sensor and cables with appropriate dummy plugs. Always apply grease on connectors and sealing plugs if earlier applied grease is dried out.



Figure 8-1: Grease for Subconn plug

8.3 Factory service

Factory service is offered for maintenance, repair or calibration.

When returning Motus Wave Sensor, always include the Instrument Service Order, Form No. 135; see our web pages under 'Support and Training'.

Normal servicing time is four to six weeks, but in special cases the service time can be reduced.

A main overhaul and service is recommended at the factory every three years

8.4 Example of Test & Specifications sheet and Certificates

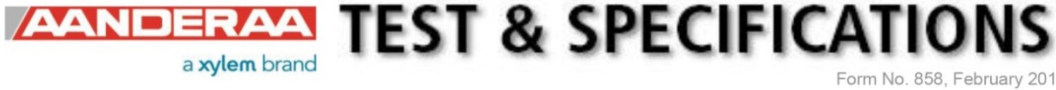

Program Version: 5.0.1

Product: 5729

Serial No: 2

Visual and Mechanical Checks:

- 1.1 Soldering quality.....
- 1.2 Visual surface.....
- 1.3 Galvanic isolation between housing and electronics

Current Drain and Voltages:

- 2.1 Average Current Drain @ RS232, 2 minute output interval,12V (Max.: 110 mA)..... 100.0 mA
- 2.2 Average Current Drain @ AiCaP, 2 minute output interval,12V (Max.: 110 mA) 100.0 mA
- 2.3 Quiescent Current Drain @ RS232, 12V (Max.: 8000 µA)..... 6000 µA
- 2.4 Quiescent Current Drain @ AiCaP, 12V (Max.: 8000 µA)..... 6000 µA
- 2.5 DSP IO Voltage, Jx.x. (3.3 ±0.15V)..... 3.28 V
- 2.6 DSP Core Voltage, Jx.x(1.8 ±0.05 V)..... 1.82 V

Performance test:

- 3.1 Check external compass input function
- 3.2 Hm0 @ 1 sec. in final test jig (2.83±0.01m) 2.830 m
- 3.3 Hm0 @ 5 sec. in final test jig (2.83±0.01m) 2.830 m
- 3.4 Hm0 @ 30 sec. in final test jig (2.83±0.01m) 2.830 m
- 3.5 Wave Peek Direction @ 1 sec. in final test jig (yyy°±1°) 180.00 m
- 3.6 Wave Peek Direction @ 5 sec. in final test jig (yyy°±1°) 180.00 m
- 3.7 Wave Peek Direction @ 30 sec. in final test jig (yyy°±1°) 180.00 m

Date: 27 Feb 2017

Sign:

A handwritten signature in black ink, which appears to read 'Jostein Hovdenes'.

Jostein Hovdenes, Product Manager, Sensors

Figure 8-2: Example of Test & Spec. sheet

CHAPTER 9 Installation

9.1 Mounting Brackets

- Horizontal “Mounting plate” Aanderaa part no: 0975853.

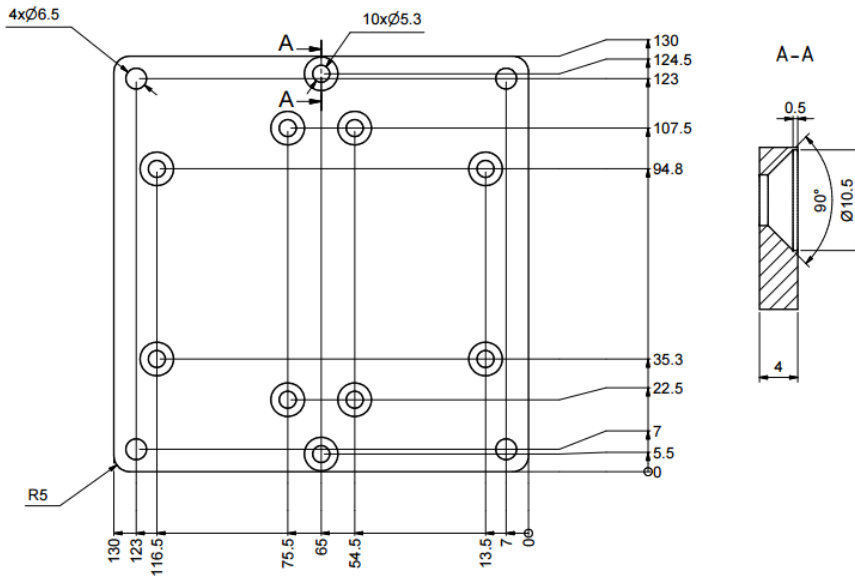

Figure 9-1: Horizontal mounting plate

- Vertical “Wall mount bracket” Aanderaa part no: 0975854.

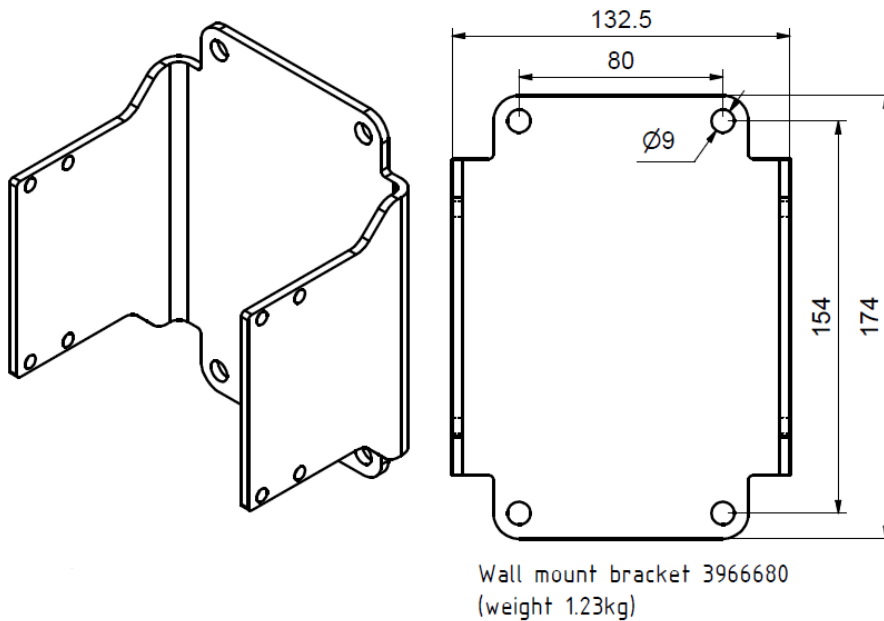

Figure 9-2: Vertical mounting plate

9.2 Connecting Cables

Aanderaa offers a wide range of standard cables; see Table 8-1 for more details.

	<p>a) Cable 5835 with connectors</p> <ul style="list-style-type: none"> • MCIL10F to SmartGuard AiCaP connector (M12) • Length: 1.5m
	<p>b) Cable 5834 with free end</p> <ul style="list-style-type: none"> • MCIL10F to pre-crimped single wires • Length: 1.5m • Used together with cable glands • Connects to SmartGuard Link cable, AiCaP
	<p>c) Configuration Cable 5789</p> <ul style="list-style-type: none"> • MCIL10F to 9pin D-sub female & USB. • Length: 1.6m
	<p>d) Compass cable 5855 with free end</p> <ul style="list-style-type: none"> • Used together with external “general type compass” • MCIL6M to free end • Length: 0.6m
	<p>e) Compass cable 5856S with connectors</p> <ul style="list-style-type: none"> • Used together with Aanderaa 4164A compass • MCIL6M to 10pin lemo plug • Length: 5m

Table 8-1: Cables

9.3 Mounting considerations EMM 2.0

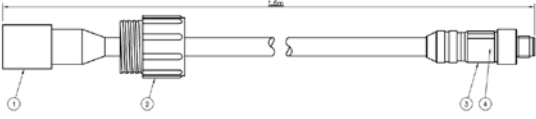
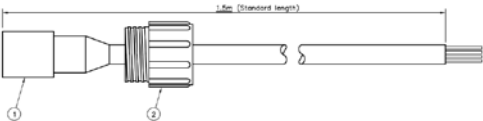
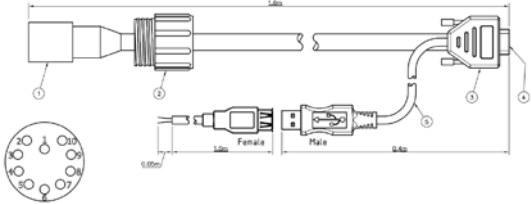
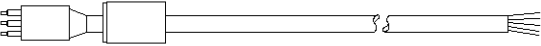
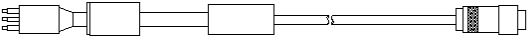
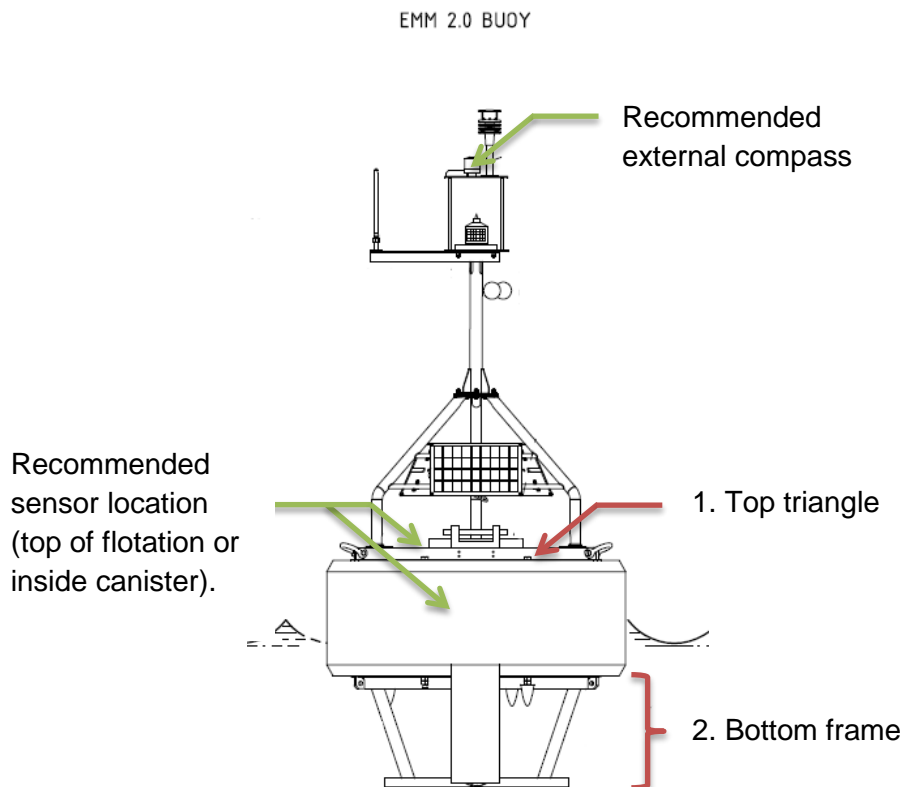

Figure 9-3: Mounting considerations EMM 2.0

9.3.1 Magnetic distortion areas on EMM 2.0

- Areas around parts made of steel. See figure 5.
 1. Top triangle (hot dip galvanized steel).
 2. Bottom frame (hot dip galvanized steel).
- Due to the magnetic influence from metal parts on a standard EMM 2.0 it is recommended to add an external compass to the sensor or to the system.
- NOTE! After external compass has been mounted avoid mounting magnetic objects in the vicinity of the compass.

9.3.2 Recommended sensor location

- It is difficult to avoid magnetic distortion areas on the lower parts of an EMM 2.0. It is therefore recommended to add an external compass to the system.
- The best location for mounting the sensor is:
 1. As close to the center of the buoy as possible.
 2. As close to the waterline as possible.
 - For buoys with central canister it is recommended to mount the sensor inside the canister.

- For buoys without central canister the sensor can be fixed to the surface of the buoy flotation.

9.3.3 Connecting cables

- Refer to chapter 9.2 in this document.

9.3.4 Sensor mounting arrangement

- Sensor can be fixed to the surface of the flotation by using the horizontal “Mounting plate” Aanderaa part no: 5853. Drawing DID-51257.



Figure 9-4: Sensor mounted with horizontal mounting plate

9.4 Mounting considerations Tideland SB-138P

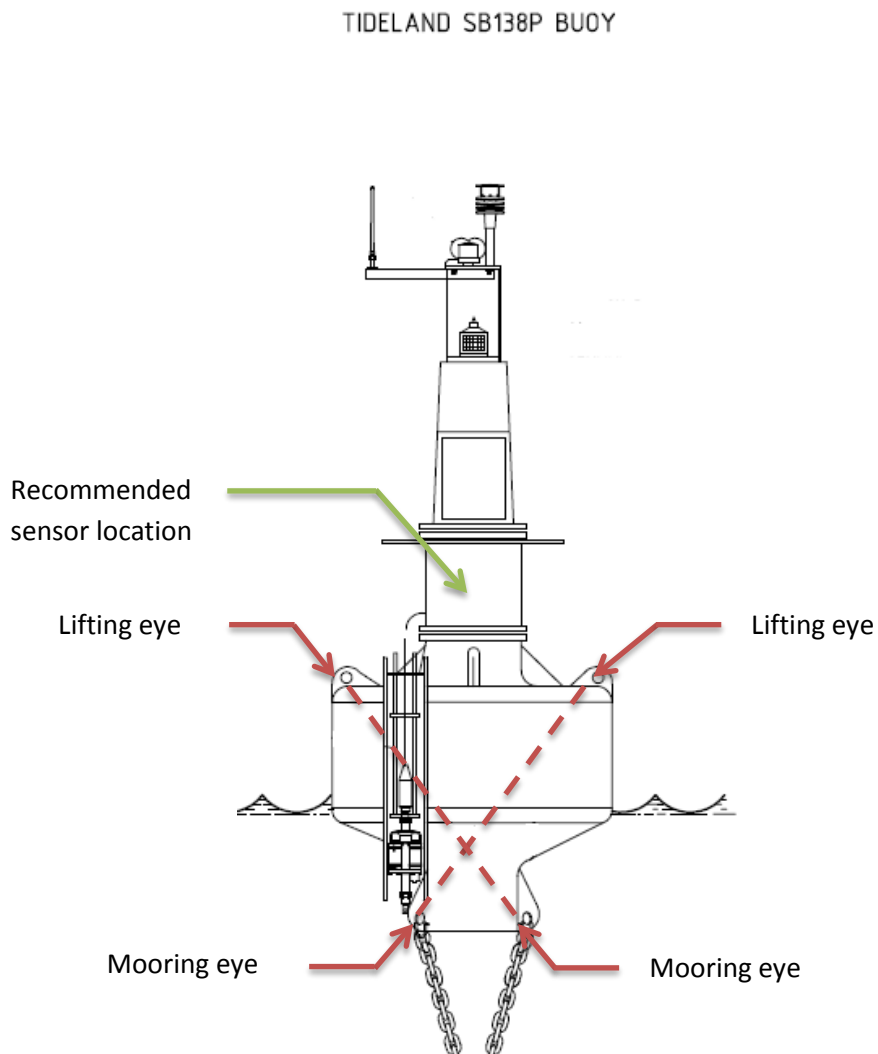

Figure 9-5: Mounting considerations Tideland SB-138P

9.4.1 Magnetic distortion areas on Tideland SB-138P

- Areas around parts made of steel. See figure 6. The SB-138P has a float section with internally cross brazed stainless steel rods that are connected to stainless steel bushings in mooring and lifting eyes. The magnetic influence from these parts is very low and will not alone affect the sensors internal compass readings.
- Due to the low magnetic influence from materials in the buoy itself it is normally not necessary to add an external compass to a Tideland SB-138P buoy.
- NOTE! After external compass has been mounted avoid mounting magnetic objects in the vicinity of the compass.

9.4.2 Recommended sensor location

- In general the best sensor location is as close as possible to the center of the buoy and as near as possible to the waterline.
- Battery weight and location is important as it will affect the buoy's point of gravity.
 - For new buoys preferred location of batteries is the lower battery tray. Preferred sensor location is just above the batteries (see figure 10).
 - For existing buoys where the battery tray is positioned higher it is recommended to use only one lead acid battery. As an option two "light weight" lithium-ion batteries can be used. Preferred sensor location is in the center just below the battery tray (see figure 11).

9.4.3 Connecting cables

- Refer to chapter 9.2 in this document.

9.5 Sensor mounting arrangement

- Using the horizontal "Mounting plate" Aanderaa part no: 5853. Drawing DID-51257 the sensor can be mounted in the center of the buoy.

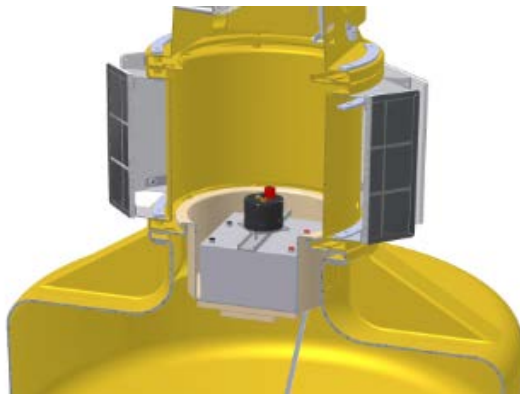

Figure 9-6: Battery and sensor location on new buoys

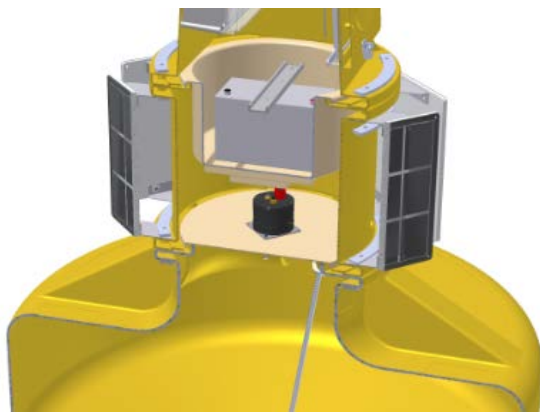

Figure 9-7: Battery and sensor on retrofit buoy

9.6 MOORING

9.6.1 General mooring information

Traditionally navigation buoys and data buoys not equipped with wave sensors have been moored with chains or a combination of chains and ropes. These traditional moorings are initially designed to stabilize and limit the buoy motion in waves. When installing a wave sensor on a data buoy, it is important that the mooring does not limit the motion we want to capture. A more flexible mooring is required so that the wave sensor captures the required movements of the buoy fully. To obtain the required flexibility one section of the mooring should consist of a rubber cord.

A typical flexible mooring normally includes these sections:

Section 1:

- Ballast and bridle chain.
- Purpose:
 - Stabilize the buoy vertically.

Section 2:

- Swivel.
- Purpose:
 - Avoid twisting of mooring due to buoy rotation.

Section 3:

- Rubber cord with safety line and short chain.
- Purpose:
 - Enables buoy to follow wave motions.
 - Chain is used to stabilize rubber cord.

Section 4:

- Rope with subsurface flotation and light chain.
- Purpose:
 - Enables slack in the upper part of the mooring enabling the buoy to capture wave motions more accurately.
 - This section is used to adjust the total mooring length.
 - To eliminate tear and wear caused by mooring rubbing against seabed the attached buoyancy lifts the rope and light chain above seabed.

Section 5:

- Sinker and ground chain
- Purpose:
 - Make a robust connection between the mooring and the bottom weight.
 - Keep the buoy positioned in its originally deployed location.

9.6.2 Mooring example EMM 2.0

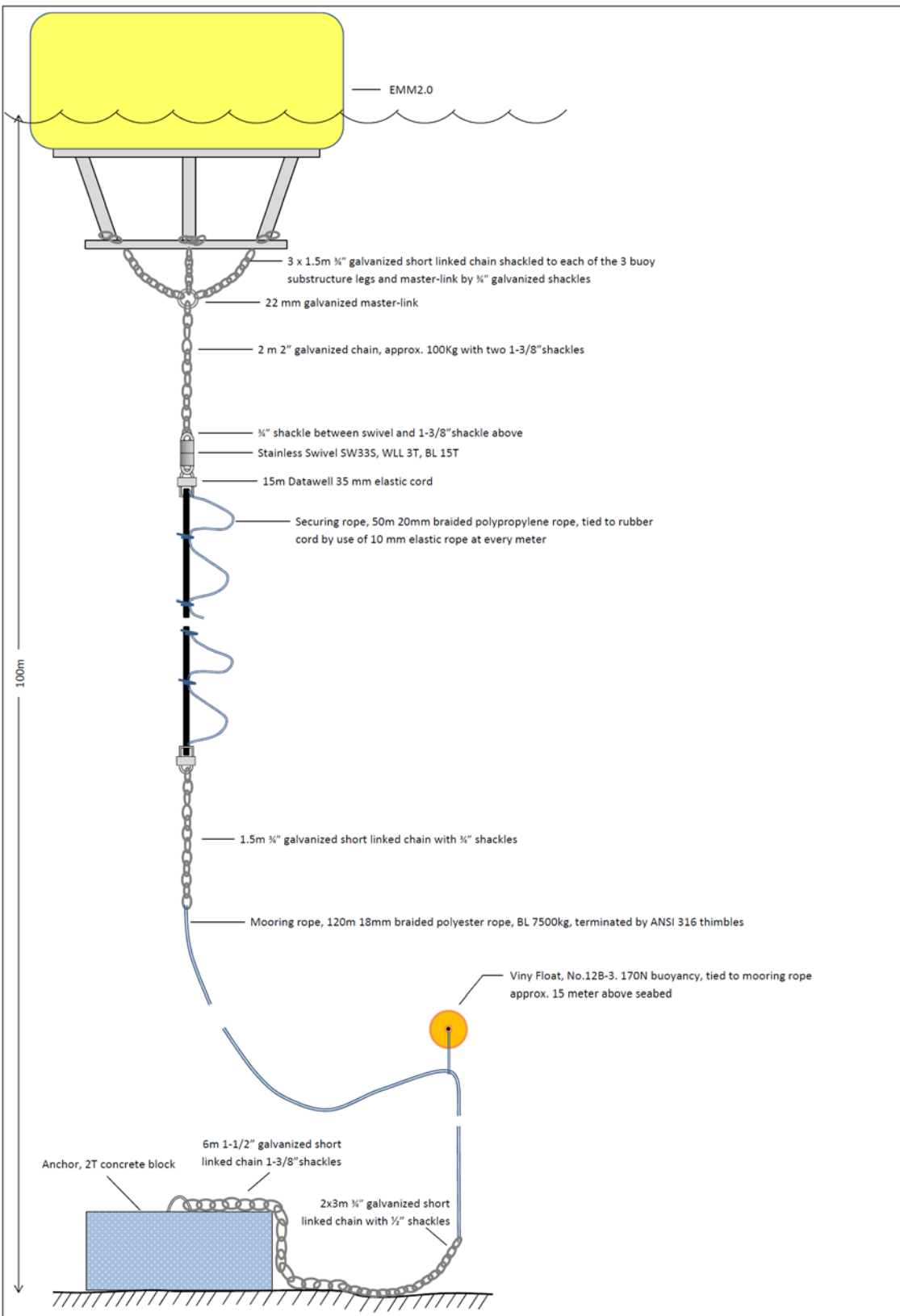

Figure 9-8: General mooring example with EMM 2.0 based on 100m water depth

See next page for detailed item list. NOTE! Lengths of ropes will vary based on local water depths.

Mooring Example Tideland SB-138

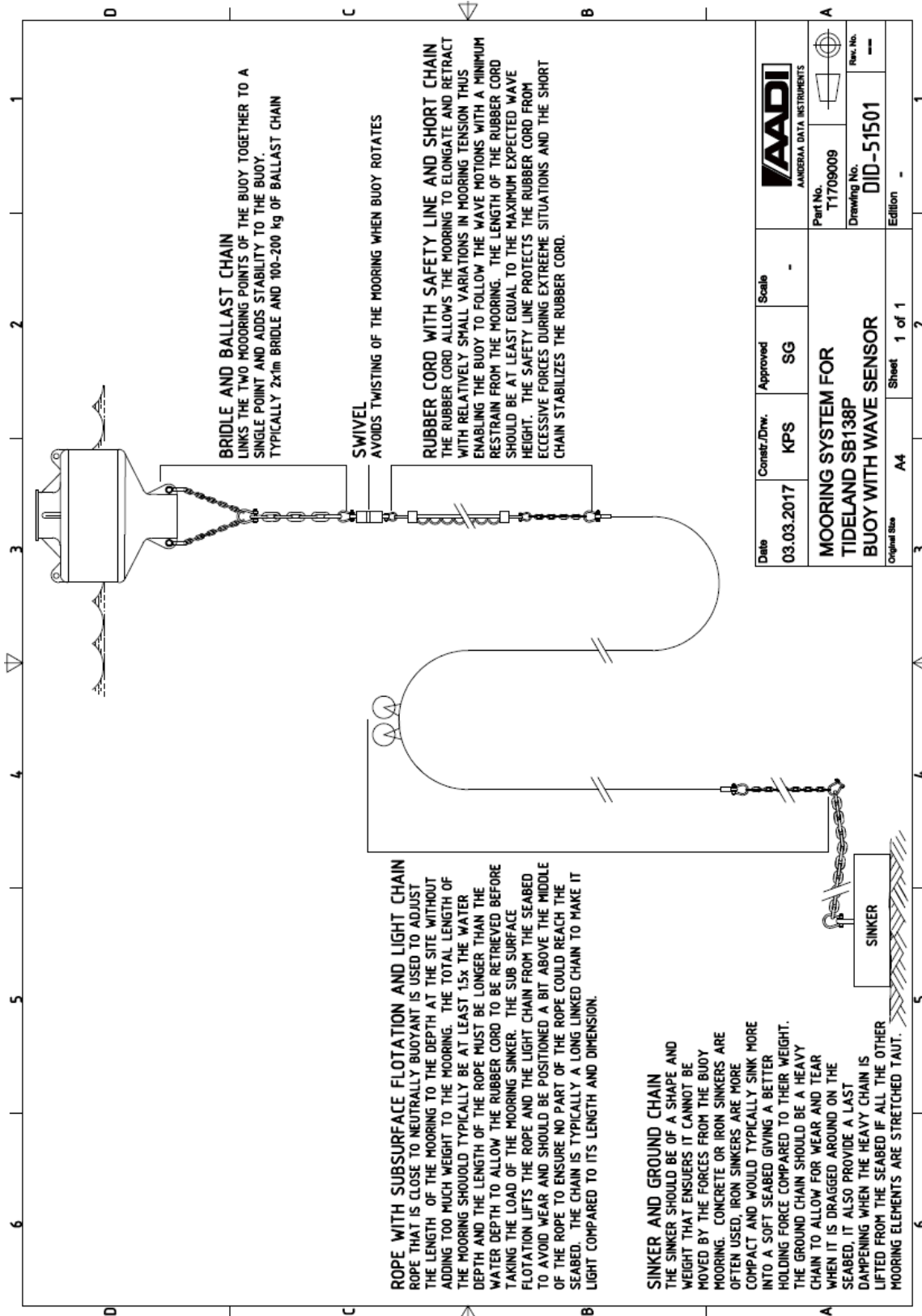

Figure 9-9: General mooring example with Tideland SB-138P based on 100m water depth

9.6.3 Mooring component example for Tideland SB-138P

Section	Description	QTY
1	Shackle AJ 852 MBL 90t w/NUT. 32-32-82mm	2
1	Chain LL GR80 16mm. Galvanized 4,3kg/m	2x2m
1	Shackle AJ 852 MBL 40t w/NUT. 22-25-52mm	1
1	Chain GR80 32mm. 23kg/m	4m
1	Shackle AJ 852 MBL 28t w/NUT, 19-22-44mm	1
2	Swivel	1
2	Shackle AJ 855 SWL 3.25t w/NUT. 16-19-27mm	2
3	Rubber cord ø35mm w/securing rope	20m
3	Shackle AJ 852 MBL 28t w/NUT, 19-22-44mm	1
3	Chain LL GR80 16mm. Galvanized 4,3kg/m	2m
3	Shackle AJ 852 MBL 28t w/NUT, 19-22-44mm	1
4	Tube Thimble G824K 316	2
4	Nylon rope 20mm BS8300	(m)
4	Float, Atlantic 280mm CH400	2
4	Chain LL GR80 16mm, galvanized 4.3kg/m	12m
4	Shackle AJ 852 MBL 28t w/NUT, 19-22-44mm	1
5	Chain GR80 32mm 23kg/m	6m
5	Shackle AJ 852 MBL 40t w/NUT. 22-25-52mm	1
5	3t sinker	1

Figure 9-10: Partlist for Tideland SB-138P mooring example

9.7 Application examples

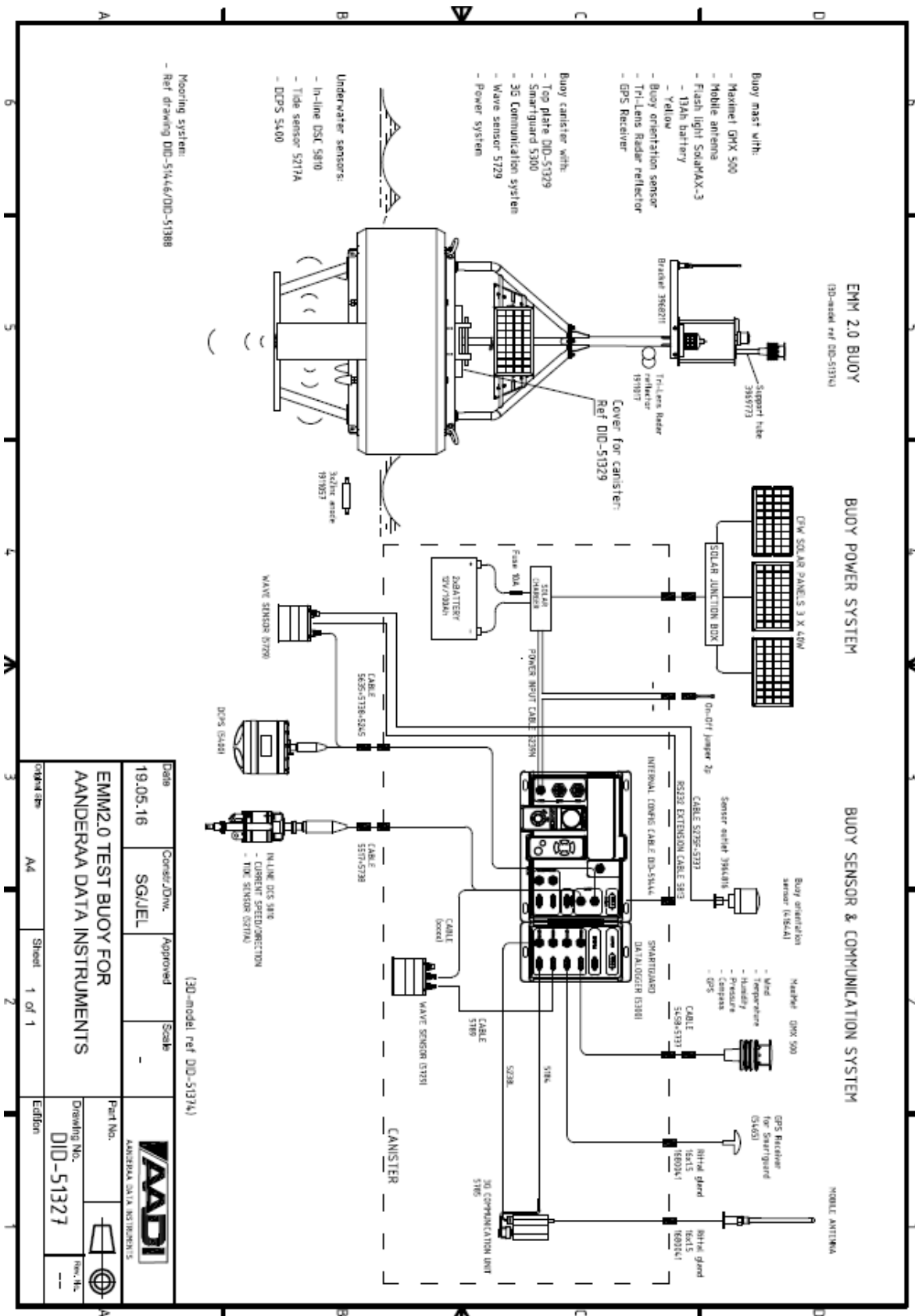

Figure 9-11: EMM 2.0 buoy with sensors and communication

Aanderaa Data Instruments AS

P.O.Box 103 Midtun, Sanddalsringen 5b, N-5843 Bergen, Norway

Tel: +47 55 60 48 00 Fax: +47 55 60 48 01

email: aanderaa.info@xylem.com - www.aanderaa.com

Aanderaa Data Instruments AS is a trademark of Xylem Inc. or one of its subsidiaries.

© 2017 Xylem, Inc. November 2017

